

SPD4000X Series Programmable Linear DC Power Supply

User Manual

EN01A

Dystrybucja i serwis 
NDN
ul. Janowskiego 15
02-784 Warszawa
www.ndn.com.pl
e-mail: ndn@ndn.com.pl
tel.: (22) 641-15-47



SIGLENT TECHNOLOGIES CO.,LTD

Contents

1	Introduction	1
2	Important Safety Information	2
2.1	General Safety Summary	2
2.2	Safety Terms and Symbols	4
2.3	Working Environment	5
2.4	Cooling requirements	5
2.5	Connect Power	6
2.6	Cleaning.....	6
2.7	Document Conventions	7
	Informations de sécurité importantes	8
	Résumé général de la sécurité	8
	Termes et symboles de sécurité.....	9
	Environnement de travail	10
	Exigences de refroidissement.....	10
	Connecter l'alimentation	11
	Nettoyage.....	11
3	Delivery of The Power Supply.....	12
3.1	General Inspection	12
3.2	Quality Assurance.....	12
3.3	Maintenance Agreement	13
4	Introduction of SPD4000X Series	14
4.1	Brief Introduction.....	14
4.2	Performance and Features.....	15
4.3	Mechanical Dimension	16
5	Quick Start.....	17
5.1	Front Panel	17
5.2	Rear Panel.....	20
6	Switch On/Off	21
6.1	Connect the Power	21
6.2	Power On.....	21
6.3	Power Off.....	21
7	Interface Introduction	22
7.1	User Interface	22
7.2	Menu Functions	23
8	Basic Operation	28

8.1	Output Settings	28
8.1.1	Set Output Voltage/Current.....	28
8.1.2	Set OVP/OCP.....	29
8.2	Configure Settings	29
8.2.1	On/Off Delays.....	29
8.2.2	Output Mode.....	30
8.3	List Setting.....	33
8.4	Waveform Display.....	34
8.5	Sense Setting	35
9	Menu Function Operations	37
9.1	System Settings.....	37
9.1.1	View Version Information	37
9.1.2	Beeper Setup	37
9.1.3	Board Test.....	38
9.1.4	System Upgrade.....	39
9.2	Communication Interface Settings	39
9.2.1	USB Setting.....	39
9.2.2	LAN Setting	39
9.2.3	GPIB Setting.....	40
9.3	Default Setting Operations	41
9.3.1	Default Settings	41
9.3.2	Factory Settings	42
9.4	Save and Recall.....	42
9.4.1	Universal Save/Recall	42
9.4.2	List Save/Recall.....	44
9.5	Calibration.....	46
9.5.1	Select Calibrate Source	46
9.5.2	Volt/Curr Calibration.....	47
10	Remote Control	48
10.1	Way to Control	48
10.2	Grammatical Conventions	49
10.3	Command Summary.....	49
10.4	Command Description	50
10.4.1	IEEE Common Command Subsystem.....	50
10.4.2	SOURCE Command Subsystem	52
10.4.3	WAVE Subsystem.....	62
10.4.4	SYSTEM Subsystem.....	64
10.4.5	STORAGE Subsystem.....	67

10.4.6	CALIBRATE Subsystem	68
10.4.7	MEASURE Subsystem.....	69
10.5	Web Service	70
10.5.1	Web Connection Method.....	70
10.5.2	Web Interface	72
10.5.3	List Operation Method.....	73
10.5.4	Import/Export List File	74
11	Troubleshooting.....	75

1 Introduction

This user manual includes important safety and installation information related to the SPD4000X series programmable linear DC power supply and includes simple tutorials for the basic operation of the supply.

2 Important Safety Information

This manual contains information and warnings that must be followed by the user for safe operation and to keep the product in a safe condition.

2.1 General Safety Summary

Please review the following safety precautions carefully to avoid personal injury or damage to this product or any product connected to it. To prevent potential danger, please use the instrument as specified.

To Avoid Fire or Personal Injury.

Use Proper Power Line.

Only use a local/state approved power cord for connecting the instrument to mains power sources. Sold to North America and other countries, it will be equipped with power cord meeting local requirements.

Ground the Instrument.

The instrument grounds through the protective terra conductor of the power line. To avoid electric shock, the ground conductor must be connected to the earth. Make sure the instrument is grounded correctly before connect its input or output terminals.

Look over All Terminals' Ratings.

To avoid fire or electric shock, please look over all ratings and signed instructions of the instrument. Before connecting the instrument, please read the manual carefully to gain more information about the ratings.

Not Operate with Suspected Failures.

If you suspect that there is damage to the instrument, please let qualified service personnel check it. Do not operate in wet/damp conditions.

Do not operate in an explosive atmosphere.

Do not operate in wet/damp conditions.

Keep the surface of the instrument clean and dry.

Electrostatic Prevention.

Operate in an electrostatic-protected area environment to avoid damages induced by static discharge. Always ground both the internal and external conductors of the cable to release a static charge before connecting.

Do Not Operate Without Covers.





Do not operate the instrument with covers or panels removed.

Do not place heavy objects on SPD4000X.

Avoid severe impact or improper placement that may damage the power supply. Do not place heavy objects on the power supply.

2.2 Safety Terms and Symbols

When the following symbols or terms appear on the front or rear panel of the instrument or in this manual, they indicate special care in terms of safety.

	<p>This symbol is used where caution is required. Refer to the accompanying information or documents to protect against personal injury or damage to the instrument.</p>
	<p>This symbol is used to denote the measurement ground connection.</p>
	<p>This symbol is used to denote a safety ground connection.</p>
	<p>This symbol shows that the switch is an On/Standby switch. When it is pressed, the scope's state switches between Operation and Standby. This switch does not disconnect the device's power supply. To completely power off the scope, the power cord must be unplugged from the AC socket after the instrument is in the standby state.</p>
	<p>This symbol is used to represent alternating current, or "AC".</p>
<p>CAUTION</p>	<p>The "CAUTION" symbol indicates a potential hazard. It calls attention to a procedure, practice, or condition which may be dangerous if not followed. Do not proceed until its conditions are fully understood and met.</p>
<p>WARNING</p>	<p>The "WARNING" symbol indicates a potential hazard. It calls attention to a procedure, practice, or condition which, if not followed, could cause bodily injury or death. If a WARNING is indicated, do not proceed until the safety conditions are fully understood and met.</p>

2.3 Working Environment

This instrument is intended for indoor use and should be operated in a clean, dry environment.

- Relative Humidity: $\leq 80\%$
- Altitude: $\leq 2000\text{m}$
- Ambient temperature: $0^{\circ}\text{C} \sim 40^{\circ}\text{C}$

Note: Direct sunlight, radiators, and other nearby heat sources should be taken into account when assessing the ambient temperature.

	WARNING: Do not operate equipment in explosive, dusty, or humid air.
---	---

2.4 Cooling requirements

This instrument relies on forced air cooling with internal fans and ventilation openings. Care must be taken to avoid restricting the airflow around the apertures (fan holes) at the back of the power supply. Please keep good ventilation when using, and regularly check the vents and fans.

Instructions not to position the equipment so that it is difficult to operate the disconnecting device.

	WARNING: Do not block the ventilation holes located on both sides of the scope. Do not allow any foreign matter to enter the scope through the ventilation holes, etc. No other objects are allowed 10cm behind the machine to ensure heat dissipation and easy operation of the disconnecting device.
---	--

2.5 Connect Power

Input Power Requirement

The SPD4000X allows a 50Hz/60Hz frequency, and four levels of AC power:

100V/120V/220V/230V±10%. You can select wanted power voltage with the "DIP Switch" at the rear panel according to the actual demand.

	<p>WARNING:</p> <p>To switch to the wanted power voltage, please disconnect the power cord first.</p>
---	--

Electrical Check

Please use the power cord provided as accessory and connects the instrument to AC power. Check the power as the following steps.

1. Connect the power supply

	<p>WARNING:</p> <p>To avoid electric shock, please make sure that the instrument is grounded correctly.</p>
---	--

2. Turn on the power switch

Press the power switch button to enter boot interface, and system return to the default settings after a while.

2.6 Cleaning

Clean only the exterior of the instrument, using a damp, soft cloth. Do not use chemicals or abrasive elements. Under no circumstances should you allow moisture to penetrate the instrument. To avoid electrical shock, unplug the power cord from the AC outlet before cleaning.

	<p>WARNING: Electrical Shock Hazard!</p> <p>No operator serviceable parts inside. Do not remove covers.</p> <p>Refer servicing to qualified personnel.</p>
---	---

2.7 Document Conventions

For convenience, text with character borders is used to represent the buttons on the front panel. For example, **Home** represents the "Home" button on the front panel. Italicized text with shading is used to represent the clickable menu/options/virtual keys on the display. For example, **Source** represents the "Source" option on the screen.

For the operations that contain multiple steps, the description is in the form of "Step 1 > Step 2 >...". As an example, follow each step in the sequence to view the version information:

Menu > **System** > **Version**

Press **Menu** corresponding menu button on the panel as step 1, press **System** corresponding menu button on the panel as step 2, and press **Version** corresponding menu button on the panel as step 3 to view the version information.

Informations de sécurité importantes

Ce manuel contient des informations et des avertissements que l'utilisateur doit suivre pour assurer un fonctionnement sûr et maintenir le produit dans un état sûr.

Résumé général de la sécurité

Veillez examiner attentivement les précautions de sécurité ci - dessous pour éviter des blessures ou des dommages corporels à ce produit ou à tout produit qui y est associé. Pour prévenir les dangers potentiels, utilisez l'instrument comme indiqué.

Évitez les incendies ou les blessures corporelles.

Utilisez le cordon d'alimentation approprié.

Vous ne pouvez connecter l'instrument à l'alimentation principale qu'à l'aide d'un cordon d'alimentation approuvé localement / par l'État. Vendu en Amérique du Nord et dans d'autres pays, il sera équipé d'un cordon d'alimentation conforme aux exigences locales.

Mettre l'instrument à la terre.

L'instrument est mis à la Terre par le conducteur de terre de protection du cordon d'alimentation. Pour éviter les chocs électriques, le fil de terre doit être mis à la terre. Assurez - vous que l'instrument est correctement mis à la terre avant de connecter les bornes d'entrée ou de sortie.

Voir les cotes de tous les terminaux.

Pour éviter un incendie ou une électrocution, consultez toutes les notes et instructions signées de l'instrument. Lisez attentivement le Manuel pour obtenir plus d'informations sur les valeurs nominales avant de connecter l'instrument.

Ne fonctionne pas lorsque l'échec est suspecté.

Ne pas utiliser dans des conditions humides / humides.

Gardez la surface de l'instrument propre et sèche.

Protection électrostatique.

Opérer dans un environnement de zone de protection électrostatique pour éviter les dommages causés par les décharges électrostatiques. Toujours mettre à la terre les conducteurs internes et externes du câble avant de le connecter pour libérer l'électricité statique.

Ne pas utiliser sans couvercle.







N'utilisez pas l'instrument sans retirer le couvercle ou le panneau.

Ne placez pas d'objets lourds sur le SPD4000X.

Évitez les impacts graves ou les placements inappropriés qui pourraient endommager l'alimentation. Ne placez pas d'objets lourds sur l'alimentation.

Termes et symboles de sécurité

Lorsque les symboles ou termes suivants apparaissent sur le panneau avant ou arrière de l'instrument ou dans ce manuel, ils indiquent un soin particulier en termes de sécurité.

	Ce symbole est utilisé lorsque la prudence est requise. Reportez-vous aux informations ou documents joints afin de vous protéger contre les blessures ou les dommages à l'instrument.
	Ce symbole avertit d'un risque potentiel de choc électrique.
	Ce symbole est utilisé pour désigner la connexion de terre de mesure.
	Ce symbole est utilisé pour indiquer une connexion à la terre de sécurité.
	This symbol shows that do not put electronic equipment as unsorted municipal waste management. Please separate collection or contact equipment suppliers.
	Ce symbole est utilisé pour représenter un courant alternatif, ou "AC".
CAUTION	Le symbole " CAUTION " indique un danger potentiel. Il attire l'attention sur une procédure, une pratique ou une condition qui peut être dangereuse si elle n'est pas suivie. Ne continuez pas tant que ses conditions n'ont pas été entièrement comprises et remplies.
WARNING	Le symbole " WARNING " indique un danger potentiel. Il attire l'attention sur une procédure, une pratique ou une condition qui, si elle n'est pas suivie, pourrait entraîner des blessures corporelles ou la mort. Si un WARNING est indiqué, ne continuez pas tant que les conditions de sécurité ne sont pas entièrement comprises et remplies.

Environnement de travail

Cet instrument est adapté à une utilisation en intérieur et doit être utilisé dans un environnement propre et sec.

- Humidité relative: $\leq 80\%$
- Altitude: $\leq 2000\text{m}$
- Température ambiante: $0^{\circ}\text{C} \sim 40^{\circ}\text{C}$

Remarque: la lumière directe du soleil, les radiateurs et les autres sources de chaleur à proximité doivent être pris en compte lors de l'évaluation de la température ambiante.

	WARNING: N'utilisez pas l'appareil dans un air explosif, poussiéreux ou humide.
---	--

Exigences de refroidissement

L'instrument repose sur un refroidissement par air forcé avec ventilateur interne et évent. Il faut faire attention à ne pas limiter le flux d'air autour de l'ouverture arrière de l'alimentation (trou du ventilateur). Gardez une bonne ventilation lors de l'utilisation et vérifiez régulièrement les événements et les ventilateurs.

Ne placez pas l'appareil dans un endroit où il est difficile de faire fonctionner le dispositif d'isolation.

	WARNING: Ne pas obstruer les trous de ventilation situés de part et d'autre de l'oscilloscope. Aucun corps étranger n'est autorisé à entrer dans la gamme par des orifices de ventilation, etc. Il ne doit pas y avoir d'autres objets à 10 cm derrière la machine pour assurer la facilité de fonctionnement du dispositif de dissipation de chaleur et d'isolation.
---	---

Connecter l'alimentation

Le SPD4000x permet des fréquences de 50Hz / 60Hz et quatre niveaux d'alimentation AC: 100V / 120V / 220V / 230V \pm 10%. Vous pouvez sélectionner la tension d'alimentation souhaitée avec le "DIP SWITCH" sur le panneau arrière en fonction des besoins réels.

	<p>WARNING:</p> <p>Pour passer à la tension d'alimentation souhaitée, débranchez d'abord le cordon d'alimentation.</p>
---	---

Inspection électrique

Veillez utiliser le cordon d'alimentation fourni en tant qu'accessoire et connecter l'instrument à une alimentation secteur. Suivez les étapes ci - dessous pour vérifier l'alimentation.

1. Connecter l'alimentation

	<p>WARNING:</p> <p>Pour éviter les chocs électriques, assurez - vous que l'instrument est correctement mis à la terre.</p>
---	---

2. Allumer l'interrupteur d'alimentation

Appuyez sur le bouton Power Switch, entrez dans l'interface de démarrage et après un certain temps, le système revient aux paramètres par défaut.

Nettoyage

Utilisez un chiffon humide pour nettoyer uniquement l'extérieur de l'instrument. N'utilisez pas de produits chimiques ou d'abrasifs. L'humidité ne peut en aucun cas pénétrer dans l'instrument. Pour éviter les chocs électriques, débranchez le cordon d'alimentation de la prise secteur avant le nettoyage.

	<p>WARNING: Danger d'électrocution!</p> <p>Il n'y a pas de pièces à l'intérieur que l'opérateur peut réparer. Ne retirez pas le couvercle.</p> <p>Veillez consulter une personne qualifiée pour les réparations.</p>
---	---

3 Delivery of The Power Supply

3.1 General Inspection

Please check the instrument according to the following steps.

Inspect the shipping container

Keep the original shipping container and cushioning material until the contents of the shipment have been completely checked and the instrument has passed both electrical and mechanical tests. The consigner or carrier will be responsible for damages to the instrument resulting from shipment. **SIGLENT** will not provide free maintenance or replacement if the instrument has been damaged in shipment.

Inspect the instrument

If there are instruments found damaged, defective or failure in electrical and mechanical tests, please contact **SIGLENT**.

Check the accessories

Please check the accessories according to the packing list. If the accessories are incomplete or damaged, please contact your **SIGLENT** sales representative.

3.2 Quality Assurance

The SPD4000X has a 3-year warranty (1-year warranty for probe and accessories) from the date of shipment, during normal use and operation. **SIGLENT** can repair or replace any product that is returned to the authorized service center during the warranty period. We must first examine the product to make sure that the defect is caused by the process or material, not by abuse, negligence, accident, abnormal conditions, or operation.

SIGLENT shall not be responsible for any defect, damage, or failure caused by any of the following:

- a) Attempted repairs or installations by personnel other than **SIGLENT**.
- b) Connection to incompatible devices/incorrect connection.
- c) For any damage or malfunction caused by the use of non-**SIGLENT** supplies. Furthermore, **SIGLENT** shall not be obligated to service a product that has been modified. Spare, replacement parts and repairs have a 90-day warranty.

The SPD4000X's firmware has been thoroughly tested and is presumed to be functional. Nevertheless, it is supplied without a warranty of any kind covering detailed performance. Products not made by **SIGLENT** are covered solely by the warranty of the original equipment manufacturer.

3.3 Maintenance Agreement

We provide various services based on maintenance agreements. We offer extended warranties as well as installation, training, enhancement and on-site maintenance, and other services through specialized supplementary support agreements. For details, please consult your local **SIGLENT** customer service center or distributor.

4 Introduction of SPD4000X Series

4.1 Brief Introduction

The SPD4000X series programmable linear DC power supply is equipped with a 4.3-inch TFT-LCD display, friendly human-machine interface, and excellent performance indicators. Real-time waveform display provides engineers with an informative user interface. The SPD4000X series consists of three models with up to four independent outputs with rated output voltage values of 32V, 12V, or 30V and the total output power of 240W, 285W or 400W. The minimum resolution can be set to 1mV/1mA. The SPD4000X is equipped with overvoltage protection and overcurrent protection for device protection. Together, these capabilities make the SPD4000X a high precision, low noise, and highly reliable power solution suitable for use from production to research. The instrument is also equipped with LAN/USB communication interface and remote web page control function to meet different application scenarios.

The rated output value of each model of SPD4000X series is shown in the following table:

Model	SPD4323X	SPD4121X	SPD4306X	Unit
Output channel number	4			CH
CH1 rated voltage/current	6/3.2	15/1.5	15/1.5	V/A
CH2 rated voltage/current	32/3.2	12/10	30/6	V/A
CH3 rated voltage/current	32/3.2	12/10	30/6	V/A
CH4 rated voltage/current	6/3.2	15/1.5	15/1	V/A
CH2, CH3 series voltage/current	60/3.2	24/10	60/6	V/A
CH2, CH3 parallel voltage/current	32/6.4	12/20	30/12	V/A
Power	240	285	400	W

4.2 Performance and Features

- Rated voltage: 32V, 12V, 30V; rated output power: 240W, 285W, 400W
- Up to four high-precision power supplies with independent controllable outputs, supporting CH2 and CH3 series and parallel connections
- Clear graphical interface with waveform and timer display modes
- 5-digit voltage and current display with minimum resolution of 1mV, 1mA
- Fast output response time: < 50us
- The high current channel support remote voltage compensation sense function. The maximum compensation voltage is 0.6V
- Overvoltage protection and overcurrent protection or safe and accurate operation
- Equipped with a 4.3-inch TFT-LCD display (480*272 resolution)
- USB and LAN standard communication
- USB-GPIB module is optional
- Excellent channel density with up to 4 channels in a 3U half rack package
- Internal data storage for setups and parameters
- Embedded Web Server with instrument communication that doesn't require software installation
- Fully SCPI programming command set support as well as a LabView driver for remote control and system automation

4.3 Mechanical Dimension

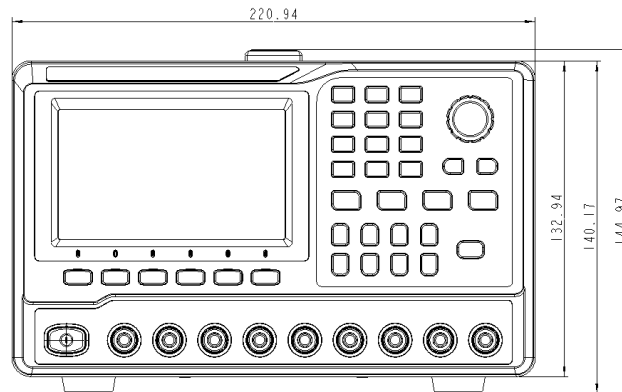

Front View

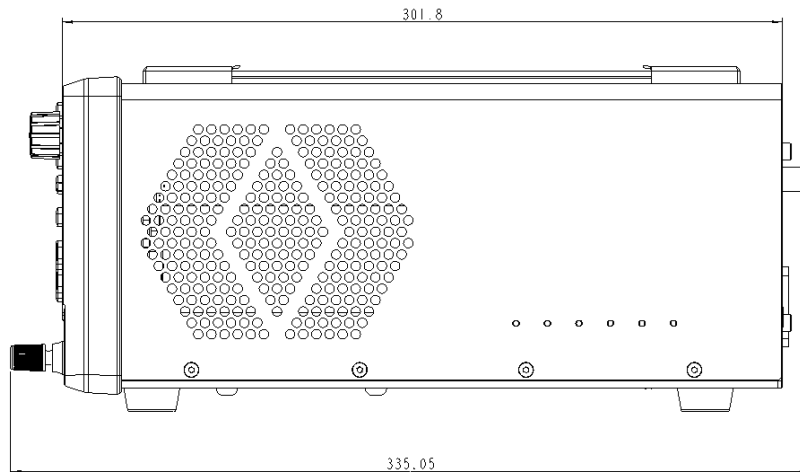

Right View (SPD4323X)

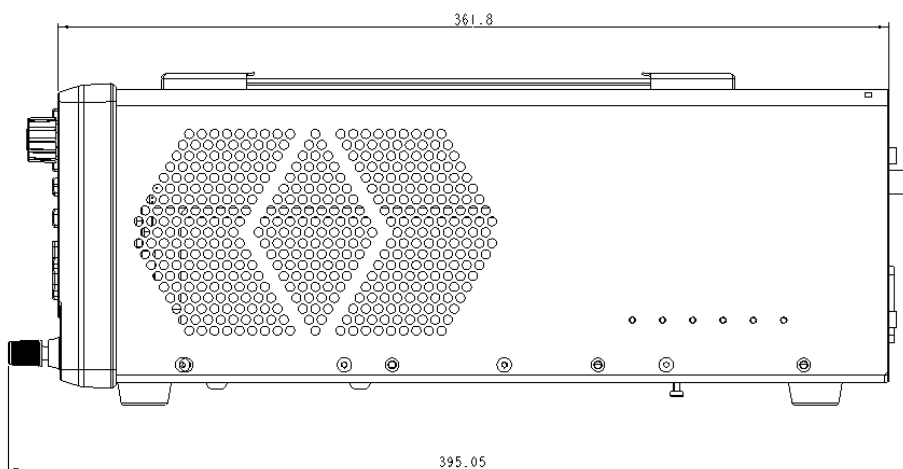

Right View (SPD4121X/SPD4306X)

5 Quick Start

5.1 Front Panel

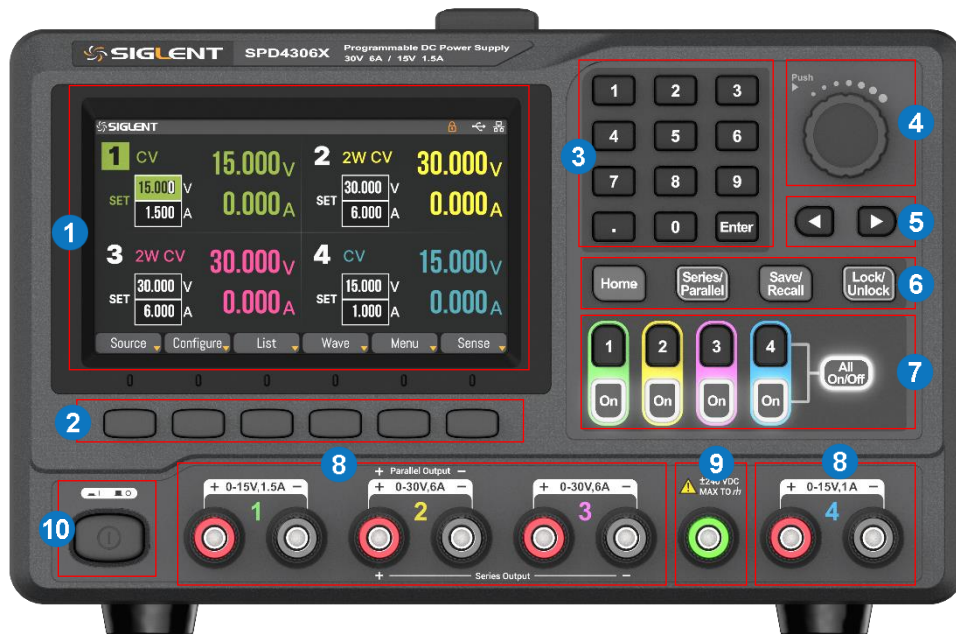

- | | |
|--------------------------------|------------------------------|
| 1. Display area | 6. Shortcut function buttons |
| 2. Menu buttons | 7. Channel control buttons |
| 3. Numeric keypad | 8. Output terminals |
| 4. Knob | 9. Ground terminal |
| 5. Right/left direction button | 10. Power switch |

Front panel description:

NO.	Item	Description
1	Display area	Equipped with a 4.3-inch TFT LCD display, used to display system output state, system parameter settings, menu options, and promotion information, etc.
2	Menu buttons	Access the display interface menu.
3	Numeric keypad	Enter a value and press Enter button to confirm the setting.
4	Knob	When setting parameters, press the knob can quickly move the cursor position, rotate the knob can increase or decrease the value. <ul style="list-style-type: none"> • Right rotation: Increase numerical value • Left rotation: Decrease numerical value
5	Right/left direction button	Press the button to move the cursor around.
6	Shortcut function buttons	<p>Home: One click to return to the main screen.</p> <p>Parallel/Series: Set CH2/3 to parallel/series mode. The parallel or series logo of the corresponding mode is displayed on the display area at the same time.</p> <p>Save/Recall: Perform save/recall operations on internal storage or external U-disk. When pressing and holding this button for more than 3 seconds, the device will take a screenshot and save it to the U-disk connected to the device.</p> <p>Lock/Unlock: Enable/disable the lock function. Short press to lock, long press to release, and the device will be automatically locked when remotely controlled.</p>
7	Channel control buttons	<p>1: Press the button to select CH1 as the current channel.</p> <p>2: Press the button to select CH2 as the current channel.</p> <p>3: Press the button to select CH3 as the current channel.</p> <p>4: Press the button to select CH4 as the current channel.</p> <p>On: Press the button to turn on/off the output of current channel. When this button is illuminated, it indicates that the channel is in an open state.</p> <p>All On/Off: Press the button to turn on/off the output of all channels. When this button is illuminated, it indicates that all channels are in an open state.</p>

NO.	Item	Description
8	Output terminals	The SPD4000X has four output terminals, which can be independently output, CH2/3 series output and CH2/3 parallel output.
9	Ground terminal	Used to connect the shell ground.
10	Power switch	Turn on/off the power.

5.2 Rear Panel

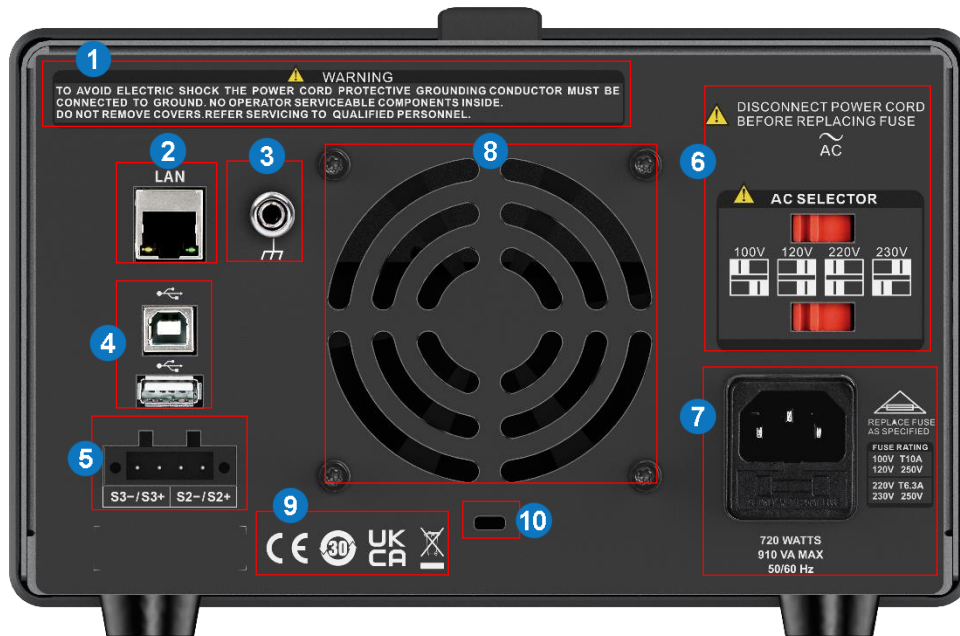

1. Warning message
2. Lan port
3. Ground port
4. USB ports
5. CH2/3 sense port
6. The DIP switch of the AC power and its identification
7. AC power socket and AC input voltage description
8. Fan vents
9. Certification mark
10. Device lock

6 Switch On/Off

6.1 Connect the Power

The specifications of the input AC power supply are as follows:

AC 100V/120V/220V/230V \pm 10%, 50/60Hz.

Please use the power cable provided in the attachment to connect the SPD4000X to the power supply. Before powering on the power supply, ensure that the fuse is working properly.

6.2 Power On

The SPD3004X is powered on manually. Please connect the power supply to the AC power through the power cord provided, turn on the power switch to enter boot interface, and system return to the default settings after a while. The instrument is turned on successfully.

When the power switch is pressed, the display area lights up, indicating that the switch is on.

Note: The power supply will generate inrush current when it is turned on. Make sure that the power supply is sufficient at the moment of startup, especially if you turn on multiple power supplies at the same time.

6.3 Power Off

When the power switch is not pressed, it indicates that the switch is off.

	<p>WARNING: It takes about 8s for the power to fully turn on and off. Do not turn on and off the power quickly. Please wait until fully closed.</p>
---	--

	<p>WARNING: Il faut environ 8 secondes pour que l'alimentation s'allume et s'éteigne complètement. Ne l'allumez et ne l'éteignez pas rapidement. Veuillez attendre la fermeture complète.</p>
---	--

Note: The power supply may be damaged when the power supply is turned off or on continuously and quickly.

7 Interface Introduction

7.1 User Interface

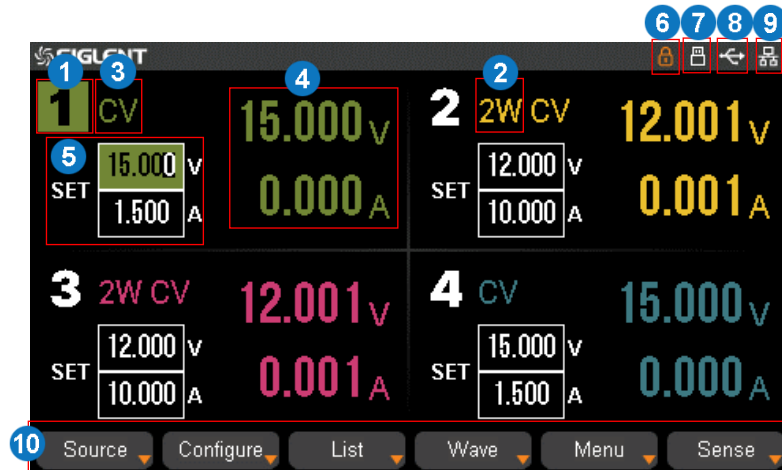

1. Channel logo.
2. CH2/CH3 working state: 2W or 4W.
3. Operating mode logo. The corresponding logo will display when working in CV or CC mode.
4. Output value. Display the current actual output voltage and current.
5. Output settings. Display the current output voltage and current settings, which can be adjusted using the numeric keypad or turning the knob on the front of the panel.
6. Lock logo. It will display when the instrument is currently locked.
7. U disk logo. It will display when there is a U-disk connection.
8. USB logo. It will display when there is a USB connection.
9. LAN logo. It will display when there is a LAN connection.
10. Front panel menu. Contains Source, Configure, List, Wave, Menu, and Sense.

7.2 Menu Functions

Item	Description
Source	<ul style="list-style-type: none"> • Voltage: Set the voltage value • Current: Set the current value • OV Protection: Set the OVP value, 0.1~1.1 times rated voltage can be set • OCP State: Turn on/off OCP function. You can use <input type="text" value="Enter"/> button or F1 to make a quick selection ON: Turn on OCP; OFF: Turn off OCP • OC Protection: Set the OCP value, 0.1~1.1 times rated current can be set • OCP Delay: Set the delay start time for OCP, 0-3600s can be set with a resolution of 0.01s. The output will be turned off when OCP is still triggered after exceeding the OCP delay start time. If the delay start time is set to 0, the output will be turned off directly when OCP is triggered • Channel control buttons can be used to quickly switch to the settings of other channels
Configure	<ul style="list-style-type: none"> • On Delays: Set the delay time for turning on the output. 0-3600s can be set with a resolution of 0.01s • Off Delays: Set the delay time for turning off the output. 0-3600s can be set with a resolution of 0.01s • Independent: Set CH2/3 to independent mode • CH2/3 Parallel: Set CH2/3 to parallel mode • CH2/3 Series: Set CH2/3 to series mode • Default delay: Set the delay time to zero after confirming the setting in the pop-up window • Coupling: Coupling mode. In the coupling mode, the <input type="text" value="ON"/> button of the channels and <input type="text" value="Run/Stopped"/> in the list interface are in synchronous mode. The channels that finish running first in list are set to zero, and the other coupling channels are in the Stopped state after the list is finished running
List	<ul style="list-style-type: none"> • Run/Stopped: Run/stopped the list • Pause: Pause the list • Repeat Count: The maximum is 9999

Item	Description	
	<ul style="list-style-type: none"> • Continuous: Continuous loop the list • Next Page: Go to the next page • Clear All: Clear all steps in the list after confirming the setting in the pop-up window • Add: Add a step to the list • Delete: Delete the current selected step in the list • Last step: Edit the last step • Next Step: Edit the next step • Back 	
Wave	<p>Waveform Settings: Enter the waveform settings interface and select the channel voltage and current that want to view the waveform. The coordinates are adaptive and cannot be adjusted by the user.</p> <ul style="list-style-type: none"> • Duration: The maximum value is 999h 59m 59s • Sample Period: The minimum value is 200ms, and the maximum is 6000ms 	
	<p>Run Stopped: Save the data to the U disk. The pop-up window prompts when data is successfully saved or no U disk insertion information is recognized.</p>	
Menu	System	<p>Version:</p> <ul style="list-style-type: none"> • Startup Times: The number of startup times • SPEC: The specifications of the instrument • Software Version: The software version number of the instrument • Product Type: The product type of the instrument • Serial Number: The serial number of the instrument • Hardware Version: The hardware version number of the instrument
		<p>Sound:</p> <ul style="list-style-type: none"> • Key Sound <p>On: Turn on key sound</p>

Item	Description	
		<p>Off: Turn off key sound</p> <ul style="list-style-type: none"> • Alarm Sound <p>On: Turn on alarm sound</p> <p>Off: Turn off alarm sound</p> <hr/> <p>Board Test:</p> <ul style="list-style-type: none"> • Keyboard: Keyboard test. The corresponding keys display on the interface will be filled for keyboard test, and the corresponding block of the key will light up in response • LED on/off: LED test • Sound: Buzzer test, the corresponding keys will sound • Back <hr/> <p>Upgrade: View the upgrade file in the U disk and select the file to upgrade the software version.</p> <ul style="list-style-type: none"> • Previous: View the previous file • Next: View the next file • Backward: Return to the previous directory • Forward: Go to file directory • Select: Select the upgrade file • Back
	Interface	<p>USB: The information about the USB port</p> <hr/> <p>LAN:</p> <ul style="list-style-type: none"> • IP Address • Subnet Mask • Gateway • DHCP <p>ON: Automatically obtain IP address</p> <p>OFF: Manually setting IP address</p>

Item	Description	
		<ul style="list-style-type: none"> • MAC Address
		GBIP: Set the GPIB address value
	Default Setting	<ul style="list-style-type: none"> • Default Settings: Restore default settings (channel parameter settings) • Factory Settings: Restore factory settings (all settings)
	Save Recall	Universal save recall: <ul style="list-style-type: none"> • Save: Save the data to native internal storage • Recall: Recall the data from native internal storage • Delete: Delete the saved data • External Save: Save the data to external storage • External Recall: Recall the data from external storage • Back
		List save recall: <ul style="list-style-type: none"> • Save: Save the list data to native internal storage • Recall: Recall the list data from native internal storage • Delete: Delete the saved list data • External Save: Save the list data to external storage • External Recall: Recall the list data from external storage • Back
	Calibrate Device	Calibrate source: Select calibration data <ul style="list-style-type: none"> • Factory Calibration: Calibrate the instrument using factory calibration data • User Calibration: Calibrate the instrument using user calibration data
Volt/Curr calibrate: <ul style="list-style-type: none"> • Save Calibrate: Save the calibration valid data 		

Item	Description
	<ul style="list-style-type: none">• Voltage Calibrate• Current Calibrate• Clear CALI data: Clear the current calibration data• Clear all data: Clear all calibration data• Back
Sense	<ul style="list-style-type: none">• CH2 Sense: Turn on/off CH2 sense• CH3 Sense: Turn on/off CH3 sense

8 Basic Operation

8.1 Output Settings

8.1.1 Set Output Voltage/Current

The output voltage and current values can be set in the **SET** area of the user interface, or in the source setting interface.

Method 1: Set in the **SET** area of the user interface

1. Select an output channel: Press the channel control button or press the left/right direction button to select the current operation channel. The channel is selected when the cursor moves to this channel.
2. Set voltage and current: In the **SET** area, use the left/right direction button to select the voltage or current, and use the numeric keypad or knob to set the value of voltage or current selected.

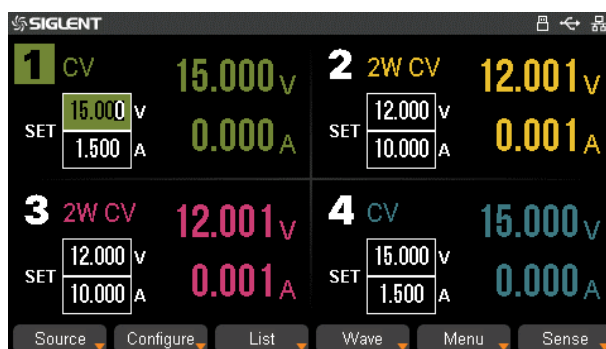

Method 2: Set in the source setting interface

1. Press **Source** corresponding menu button on the panel to enter the source setting interface.
2. Press the channel control button to select the current operation channel.
3. Use the left/right direction button to select the voltage or current, and use the numeric keypad or knob to set the value of voltage or current selected.
 - Voltage: Set the voltage value
 - Current: Set the current value

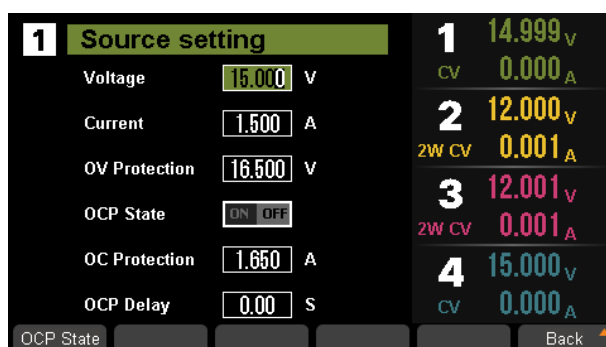

8.1.2 Set OVP/OCP

The SPD4000X equipped with overvoltage protection (OVP) and overcurrent protection (OCP) functions.

OVP setting method:

Press **Source** corresponding menu button on the panel to enter the source setting interface. Press the left/right direction button to select "OV Protection", and use the numeric keypad or knob to set the value.

OCP setting method:

OCP added the switch function selection key. Press the left/right direction button to move the cursor to **ON/OFF** area of OCP state, and press **Enter** button to select ON or OFF, then press the knob to confirm the selection. When ON is lit, it means that the OCP function is enabled. The instrument will not trigger the overcurrent protection when the OCP is in OFF state.

Do not load the voltage at the output terminals more than 10% of the rated voltage, otherwise the internal components of the instrument will be damaged.

8.2 Configure Settings

8.2.1 On/Off Delays

The SPD4000X supports the output delay function.

Setting method:

Press **Configure** corresponding menu button on the panel to enter the configure setting interface. Press the left/right direction button to select the channel that want to set the output delay on or output delay off, and use the numeric keypad or knob to set the required value.

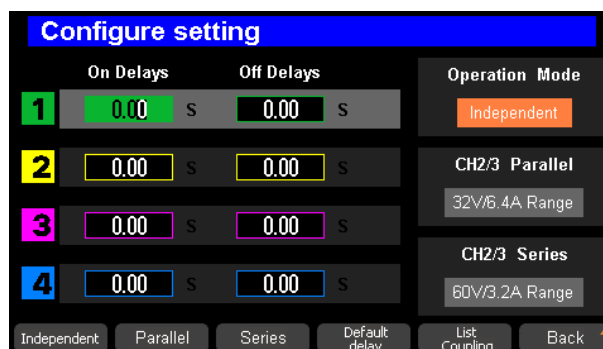

8.2.2 Output Mode

The SPD4000X has four sets of independently adjustable output sources, each output source supports constant voltage and constant current modes. The CH1/CH4 of the SPD4000X have only one independent output mode, and the CH2/CH3 have three output modes: independent, parallel and series.

In the independent mode, the output current and voltage are controlled respectively. In the parallel mode, the current value is twice that of the single channel. In the series mode, the voltage value is twice that of the single channel. When CH2 and CH3 are operating in independent mode, the Sense 4W mode can be activated. Please refer to "8.5 Sense Setting" for more details.

Constant Voltage/Current Mode

The SPD4000X supports constant voltage and constant current mode. If the output load impedance value is greater than the value obtained by dividing the voltage setting by the current setting, the instrument will operate in constant voltage mode (CV). If the output load impedance is less than the value obtained by dividing the voltage setting by the current setting, the instrument will operate in constant current mode (CC).

- In constant voltage mode, the current value is less than the set value, and the voltage value is controlled through the front panel. The user interface will display CV logo at this moment, and the voltage value is maintained at the set value. It will return to constant current mode when the output current value reaches the set value.
- In constant current mode, the current value is rated and controlled through the front panel. The user interface displays the CC logo, and the current is maintained at the set value. At this point, the voltage value is under rating. It will return to constant voltage mode when the output current value is less than the set value.

Independent Output Mode

CH1~CH4 are working in the independent mode, at the same time, they are insulated from the ground. The withstand voltage of the output terminals to the ground is $\pm 240\text{VDC}$.

Setting method:

1. Press **Configure** corresponding menu button on the panel to enter the configure setting interface.
2. Press **Independent** corresponding menu button on the panel, and the **Independent** under **Operation Mode** of the interface lights up, indicating that independent mode is selected. At this point, the **Parallel/Series** button light is off, and there is no serial or parallel logo on the user interface.

3. Connect the load to the terminals on the front panel: CH1 +/-, CH2 +/-, CH3 +/-, CH4 +/-.
4. Set voltage and current value of CH1/CH2/CH3/CH4:
 - a) Press **1** / **2** / **3** / **4** button to select the wanted channel
 - b) Move the cursor through left/right direction button to select the wanted parameter (voltage, current)
 - c) Use the numeric keypad or knob to set the required value and then press **Enter** button to complete the value setting
5. Turn on the output: Press **ON** button to turn on the output, the corresponding channel indicator light turns on immediately and "CC" or "CV" logo is showed on the current interface.

CH2/CH3 Parallel Mode

In the parallel mode, the current value is twice as much as the single channel. CH2/3 are linked internally into one channel which is controlled by CH2, and CH2 reads the parallel voltage and current values.

Setting method:

1. Press **Configure** corresponding menu button on the panel to enter the configure setting interface.
2. Press **Parallel** corresponding menu button on the panel to enable CH2/3 parallel mode, and the range of CH2/CH3 parallel voltage/current values under **CH2/3 Parallel** lights up, indicating that parallel mode is selected. At this point, the **Parallel/Series** button light is on, and there is "CH2/3 Parallel" logo on the user interface.
3. Connect the load to the terminals on the front panel: CH2 +/-.
4. Set voltage and current value.
 - a) Press **2** button to select the channel 2
 - b) Move the cursor through left/right direction button to select the wanted parameter (voltage, current)
 - c) Use the numeric keypad or knob to set the required value and press **Enter** to complete the value setting
5. Press **On** button corresponding CH2 to turn on the output.

CH2/CH3 Series Mode

In the series mode, the voltage value is twice compared with that of single channel. CH2/3 are linked internally into one channel which is controlled by CH2, and CH2 reads the parallel voltage and current values.

Setting method:

1. Press **Configure** corresponding menu button on the panel to enter the configure setting interface.
2. Press **Series** corresponding menu button on the panel to enable CH2/3 series mode, and the range of CH2/CH3 series voltage/current values under **CH2/3 Series** lights up, indicating that series mode is selected. At this point, the **Parallel/Series** button light is on, and there is "CH2/3 Series" logo on the user interface.
3. Connect the load to the terminals on the front panel: CH2+ & CH3-.
4. Set voltage and current value.
 - a) Press **2** button to select the channel 2
 - b) Move the cursor through left/right direction button to select the wanted parameter (voltage, current)
 - c) Use the numeric keypad or knob to set the required value and press **Enter** to complete the value setting
5. Press **On** button corresponding CH2 to turn on the output.

Note: Users can also use the **Parallel/Series** button on the front panel to select independent, parallel, or series modes directly.

8.3 List Setting

Press **List** corresponding menu button on the panel to enter the output list setting interface and set the list.

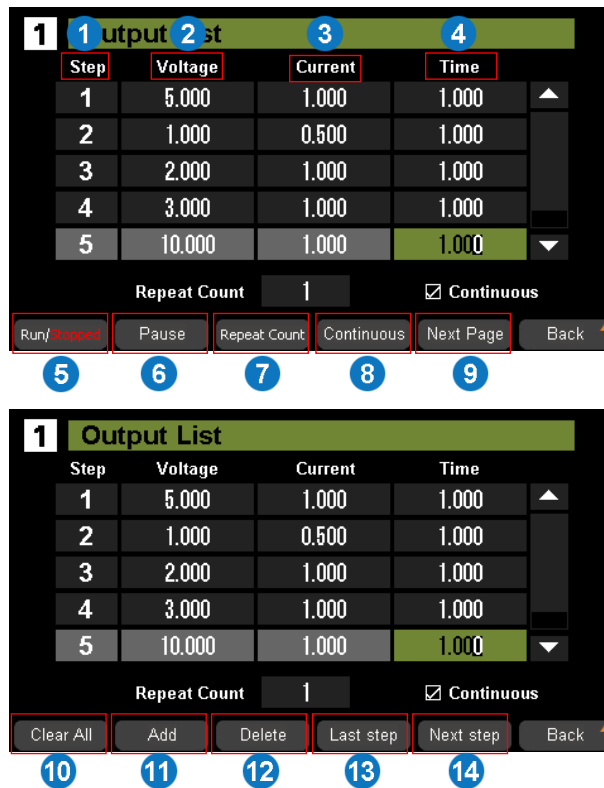

1. Step
2. Voltage: Set the output voltage corresponding to the number of steps. Select the number of steps you want to set and use the numeric keypad or knob to set the value
3. Current: Set the output current corresponding to the number of steps. Select the number of steps you want to set and use the numeric keypad or knob to set the value
4. Time: Set the running time of the current step
5. Run/Stopped: Run/stopped the list
6. Pause: Pause the list
7. Repeat Court: The maximum is 9999
8. Continuous: Continuous loop the list
9. Next Page: Go to the next page
10. Clear All: Clear all steps in the list after confirming the setting in the pop-up window
11. Add: Add a step to the list
12. Delete: Delete the current selected step in the list
13. Last step: Edit the last step
14. Next Step: Edit the next step

8.4 Waveform Display

SPD4000X can display the changes of the output voltage and current of the channel in real time through the form of curve plotting.

Setting method:

1. Set channel output parameters.
2. Press **Wave** corresponding menu button on the panel to enter the waveform display interface.

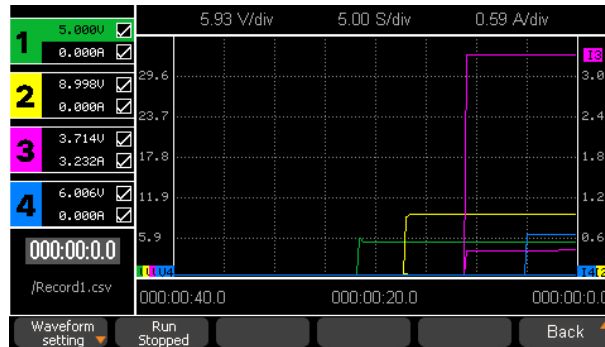

3. Press **Waveform setting** corresponding menu button on the panel to enter the waveform setting interface.
 - Use the left/right direction button to move the cursor to select the parameter that you want to display the waveform, and press **Enter** button to confirm or cancel the selection.
 - Use the left/right direction button to move the cursor to the Save Settings area, where the duration and sample period can be set by numeric keypad or knob, and press **Enter** button to confirm the setting.

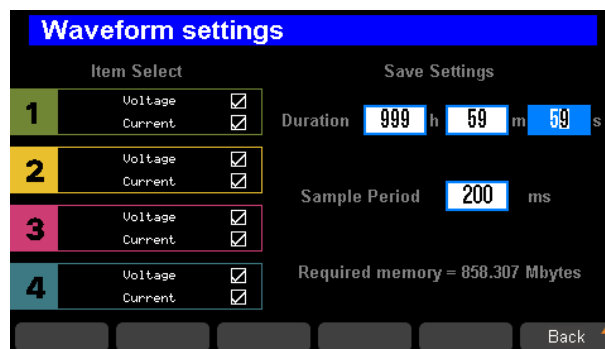

Duration: The maximum value is 999h 59m 59s

Sample Period: The minimum value is 200ms, and the maximum is 6000ms

- Return to the waveform display interface, press the **ON** button corresponding to the selected channel to open the channel output, and then you can observe the real-time change of output parameters (voltage/current).

Note: The color of the output parameter waveform curve corresponds to the color of the channel.

8.5 Sense Setting

Only CH2 and CH3 can activate 4W sense mode, and 4W sense mode is not supported in series or parallel mode. When this mode is turned on and the wires are correctly connected, it can automatically compensate for the voltage drop of the positive and negative output lines, ensuring that the voltage of the remote device to be tested is equal to the set voltage of the power supply. To use this function, you need to use the voltage sense connector in the attachment.

Setting method:

- Press **Sense** corresponding menu button on the panel to enter the sense setting interface.
- Press **CH2 sense** or **CH3 sense** corresponding menu button on the panel or use the left/right direction button to select the CH2/3 4W sense mode, and then press **Enter** button to turn on or turn off it. The 4W sense function is enabled when "ON" is lit.

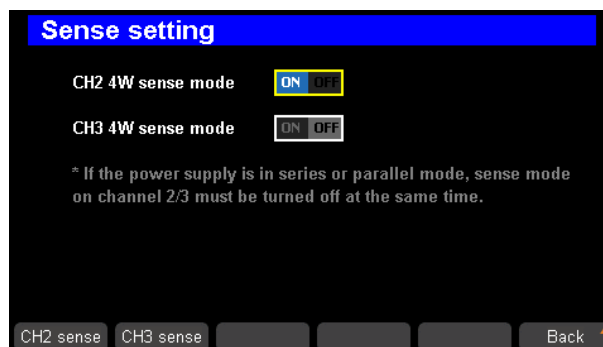

- When CH2 activates 4W sense mode, it is necessary to connect the positive and negative voltage sense wires after the front panel of the machine has correctly connected the output positive and negative wires. One end of the positive voltage sense line and the negative voltage sense line are respectively connected to S2+ and S2- on the rear panel of the power supply, and the other end is correspondingly connected to the positive and negative terminals of the remote device to be tested. Similarly, CH3 also need to connect S3+ and S3-. A single equipment under test needs to connect a total of four wires, as shown in the following figure.

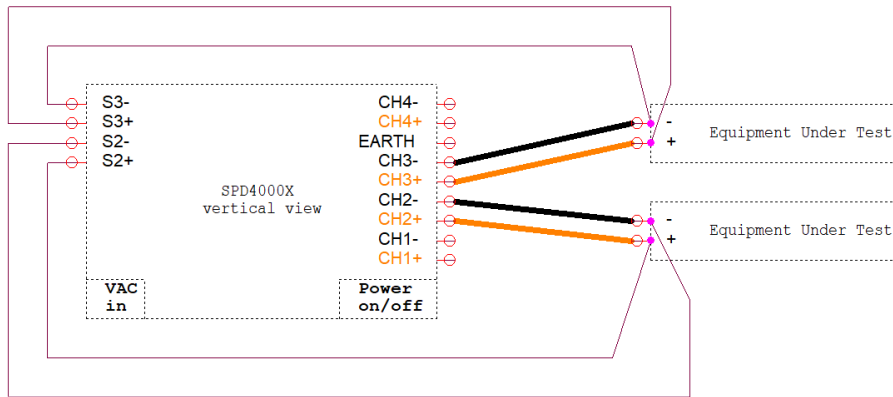

4. Self made voltage sense wires, requiring a metal conductive tail, with a recommended length of 1cm. Place the tail end at the corresponding position of the voltage sensing connector, tighten the corresponding upper screw with a screwdriver, and secure the wiring. After connecting the wires, insert the voltage sensor into the rear panel of the machine, tighten the screws on both sides with a screwdriver, and secure the connector.

Note:

1. In 4W sense mode, if one or two output positive and negative wires are not reliably connected, it will enter an internal short-circuit current limiting protection state. At this time, it is necessary to manually turn off the output and check the wiring.
2. In 4W mode, if one or two voltage sensing wires S+/S- are not reliably connected, the actual output voltage will be higher.
3. Please be careful not to short-circuit between voltage sense wires.

9 Menu Function Operations

9.1 System Settings

9.1.1 View Version Information

Press **Menu** > **System** corresponding menu button on the panel to select **Version** through the left/right direction button. Press **Enter** button to enter the version information display interface.

The version information includes: startup times, spec, software version, product type, serial number, and hardware version.

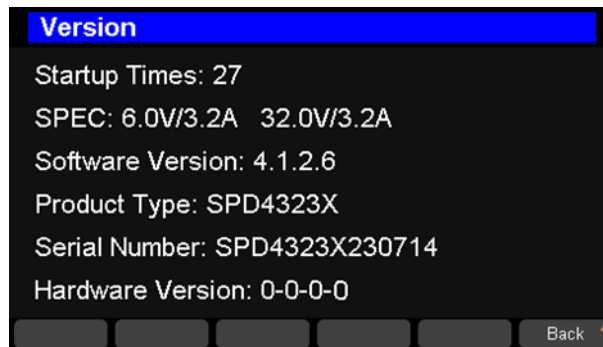

9.1.2 Beeper Setup

Press **Menu** > **System** corresponding menu button on the panel to select **Sound** through the left/right direction button. Press **Enter** button to enter the sound setting interface.

Select the sound type you want to set, move the cursor to **ON**, and then press **Enter** button to confirm the selection. **ON** will be lit and the buzzer will be turned on at the same time. Move the cursor to **OFF** and press **Enter** to confirm the selection, the buzzer will be turned off.

- Key Sound: On: Turn on key sound; Off: Turn off key sound
- Alarm Sound: On: Turn on alarm sound; Off: Turn off alarm sound

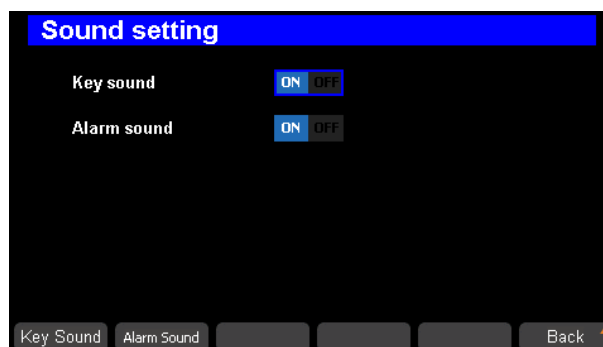

9.1.3 Board Test

Press **Menu** > **System** corresponding menu button on the panel to select **Board Test** through the left/right direction button. Press **Enter** button to enter the board test interface, where you can test the keyboard, LED and sound.

- Keyboard: Keyboard test, the corresponding key display on the screen will be filled for keyboard test, and the corresponding block of the button will light up in response.
- LED on/off: LED light on test.
- Sound: Buzzer test, the corresponding keys will sound.

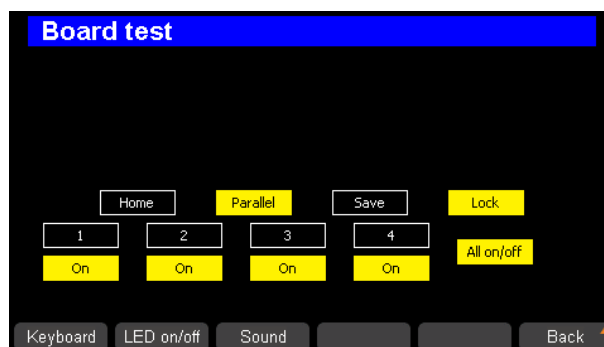

9.1.4 System Upgrade

Please follow the steps below to upgrade the firmware:

1. Download the firmware upgrade package from the official website.
2. Copy the .ADS file in the upgrade package to the root directory of the U disk.
3. Insert the U disk into the USB port of the rear panel.
4. Press **Menu** > **System** corresponding menu button, use left/right direction button to select **Upgrade**, and then press **Enter** button to confirm the selection.
5. Select the upgrade file and press **Enter** button to confirm, and the upgrade progress bar will pop up. The instrument will restart after successful upgrade. Otherwise, the upgrade failure information is displayed in the pop-up window.

Any operation that interrupts the upgrade process may cause upgrade failure or even render the machine unable to be restarted. Do not remove the U disk or make any changes to the power supply during the upgrade process.

9.2 Communication Interface Settings

9.2.1 USB Setting

USB cannot be edited and can only be viewed.

Setting method:

Press **Menu** > **Interface** corresponding menu button on the panel, and select **USB** through the left/right direction button. Press the **Enter** button to confirm and view the information about connected USB devices.

9.2.2 LAN Setting

The SPD4000X supports the DHCP function, users can set IP address either automatically or manually. When setting manually, the DHCP switch, IP address, subnet mask address, and gateway address can be set.

Setting method:

1. Press **Menu** > **Interface** corresponding menu button on the panel, and select **LAN** through the left/right direction button. Press the **Enter** button to enter the LAN setting interface.

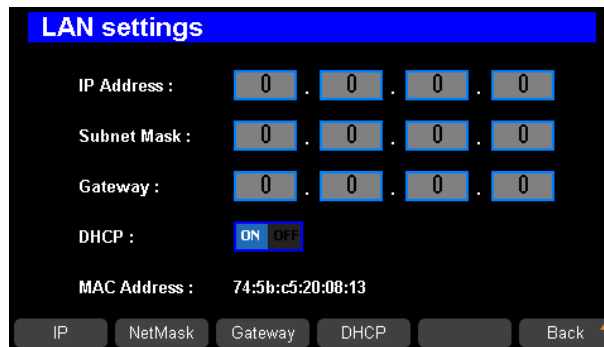

2. Press the right/left direction button or press **DHCP** corresponding menu button on the panel to keep the cursor on the DHCP line, and then press **Enter** button to set DHCP to ON or OFF.
 - ON: The SPD4000X automatically sets its IP address, subnet mask, and gateway based on the network it is connected to.
 - OFF: User set the IP address, subnet mask address and gateway address manually by pressing **IP**, **Subnet Mask** and **Gateway** corresponding menu buttons on the panel respectively, and use the numeric keypad or knob to complete the address setting.

9.2.3 GPIB Setting

Press **Menu** > **Interface** corresponding menu button on the panel, and select **GPIB** through the left/right direction button. Press the **Enter** button to enter the GBIP setting interface and set GPIB address value by using numeric keypad or knob.



9.3 Default Setting Operations

9.3.1 Default Settings

Press **Menu** > **Default Setting** corresponding menu button on the panel, and select **Default Settings** through the left/right direction button. Press the **Enter** button to confirm the selection, and complete the default settings according to the pop-up prompt.

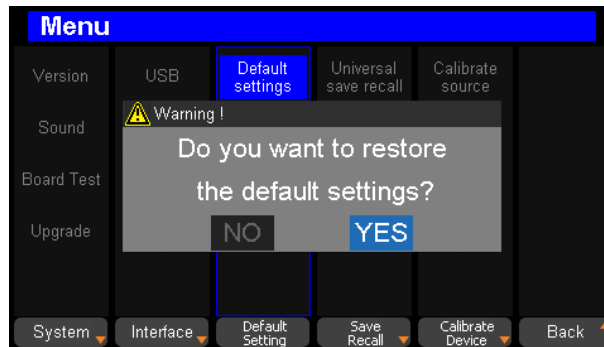

The default settings include the following:

- Set CH2/CH3 as independent mode
- Turn off the 4W Sense mode of CH2/CH3
- Set waveform display to draw all channel voltage/current waveforms, set waveform duration to 0h 0min 30s, and waveform sample period to 200ms
- Set the key sound and alarm sound to on
- Set the list coupling state to all channels closed
- Set the voltage/current values of all channels to 0
- Set OVP and OCP to maximum values
- Set OCP state to off and OCP delay to 0
- Set the on/off delays to 0
- Set the calibration source to factory calibration data
- The voltage/current/time value in the list of all channels are cleared to 0, the number of repeat count is set to 1, and the continuous state is closed

9.3.2 Factory Settings

Setting method:

Press **Menu** > **Default Setting** corresponding menu button on the panel, and select **Factory Settings** through the left/right direction button. Press the **Enter** button to confirm the selection, and complete the factory settings according to the pop-up prompt.



The factory settings add the following contents to the default settings:

- Set DHCP to on
- Set IP, Subnet Mask, Gateway, GBIP Address to 0

9.4 Save and Recall

The SPD4000X supports saving the current settings to native internal storage or an external U disk, users can recall the saved file to restore the settings. If the External mode is selected, the data will be saved in the external U disk and can be recalled in the Recall mode

Eight group setups can be saved in memory. The contents of the setup file including:

- Independent/series/parallel mode
- Output voltage/current value

9.4.1 Universal Save/Recall

Setting method:

1. Set the state that you wanted.
2. Press **Menu** > **Save/Recall** corresponding menu button on the panel, select **Universal save recall** through the left/right direction button, and then press the **Enter** button to enter the universal save/recall setting interface.

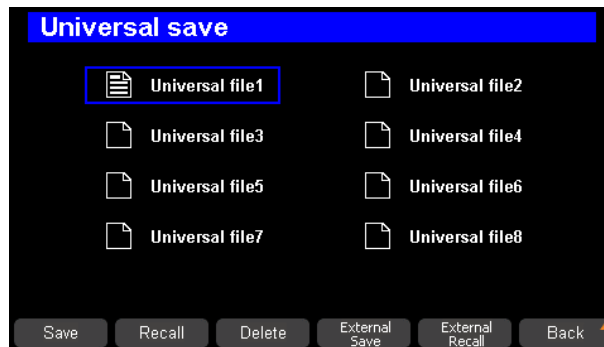

- Save: Save the data to native internal storage
- Recall: Recall the data from native internal storage
- Delete: Delete the saved data
- External Save: Save the data to external storage
- External Recall: Recall the data from external storage

3. Save the data to native internal storage.

Press the left/right direction button to select a file saving location (Universal file1 ~ Universal file8), and press the **Save** corresponding menu button on the panel to save the current settings on the native internal storage. The prompt window "Save successfully" will pop up when the file is saved successfully and the corresponding file icon will change to .



4. Save the data to external storage.

After connecting a U disk to the SPD4000X, press **External Save** corresponding menu button on the panel, and the data will be saved in the U disk., The prompt window "Please insert U-disk!" will pop up if no U disk is currently available.

5. Recall the data from native internal storage.

- 1) Press the left/right direction button to select the saved file that you want to invoke (Universal file1 ~ Universal file8)
- 2) Press **Recall** corresponding menu button on the panel to recall the selected file. The

prompt window "Recall successfully" will pop up when the file is recalled successfully.



6. Recall the data from external storage.

Press the **External Recall** corresponding menu button on the panel to recall the selected file to recall the data stored on an external U disk.

Note: If you want to delete a file that has been saved, use the left/right direction button to select the file, and press **Delete** corresponding menu button on the panel to delete it.

9.4.2 List Save/Recall

Setting method:

1. Set the state that you wanted.
2. Press **Menu > Save/Recall** corresponding menu button on the panel, select **List save recall** through the left/right direction button, and then press the **Enter** button to enter the list save/recall setting interface.

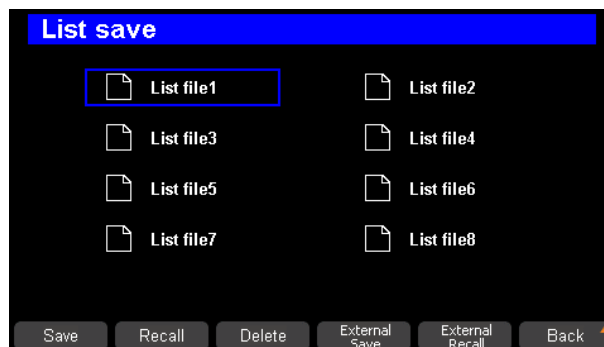

- Save: Save the list data to native internal storage
- Recall: Recall the list data from native internal storage
- Delete: Delete the saved list data
- External Save: Save the list data to external storage
- External Recall: Recall the list data from external storage

3. Save the list data to native internal storage.

Press the left/right direction button to select a file saving location (List file1 ~ List file8), and press the **Save** corresponding menu button on the panel to save the current settings on the native internal storage. The prompt window "Save successfully" will pop up when the file is saved successfully and the corresponding file icon will change to .



4. Save the list data to external storage.

After connecting a U disk to the SPD4000X, press **External Save** corresponding menu button on the panel, and the list data will be saved in the U disk. The prompt window "Please insert U-disk!" will pop up if no U disk is currently available.

5. Recall the list data from native internal storage.

- 1) Press the left/right direction button to select the saved file that you want to recall (List file1 ~ List file8)
- 2) Press **Recall** corresponding menu button on the panel to recall the selected file. The prompt window "Recall successfully" will pop up when the file is recalled successfully.

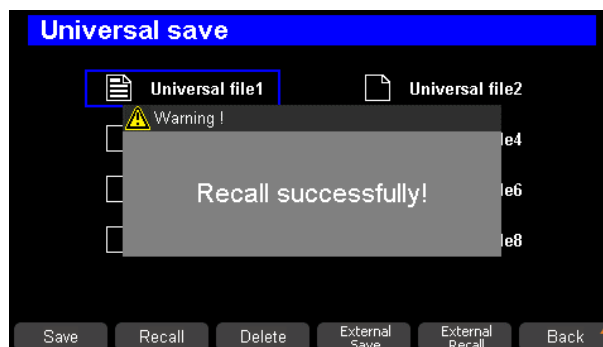

6. Recall the list data from external storage.

Press the **External Recall** corresponding menu button on the panel to recall the selected file to recall the data stored on an external U disk.

Note: If you want to delete a file that has been saved before, use the left/right direction button to select the file, and press **Delete** corresponding menu button on the panel to delete it.

9.5 Calibration

The SPD4000X supports manual calibration, users can recalibrate the instrument by using the factory calibration data or custom calibration data.

Factory setting guarantees one year accuracy, and the recommended calibration frequency is 1 time/year.

9.5.1 Select Calibrate Source

Press **Menu** > **Calibrate Device** corresponding menu button on the panel, select **Calibrate Source** through the left/right direction button, and then press the **Enter** button to enter the calibrate source select interface.



If the state of "User Calibration source" is "ON", it indicates that user calibration data is currently selected as the calibration source. If the state of "User Calibration source" is "OFF", it indicates that factory calibration data is currently selected as the calibration source.

- Factory Calibration: Calibrate the instrument using factory calibration data
- User Calibration: Calibrate the instrument using user calibration data

9.5.2 Volt/Curr Calibration

1. Press **Menu** > **Calibrate Device** corresponding menu button on the panel, select **Volt/Curr calibrate** through the left/right direction button, and then press the **Enter** button to enter the Volt/Curr calibration interface.

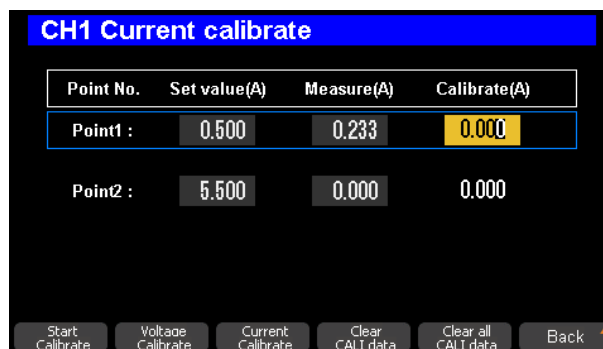
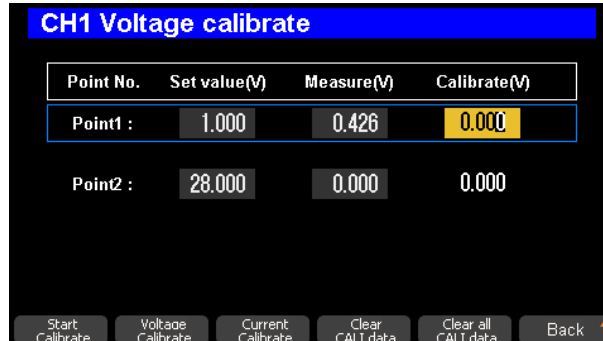

2. Select a channel that you want to Calibrate by pressing the channel control button. Press **Voltage Calibrate** or **Current Calibrate** corresponding menu button on the panel to select the parameter that you want to calibrate, and select the calibration point by the left/right direction button, then use the numeric keypad or knob to set the calibration point value. After completing the settings, press **Start Calibrate** corresponding menu button on the panel to start calibrate.

Calibration data can be cleared by the following steps:

1. Press **Menu** > **Calibrate Device** corresponding menu button on the panel, select **Volt/Curr calibrate** through the left/right direction button, and then press the **Enter** button to enter the Volt/Curr calibration interface.
2. Press **Clear CALI data** corresponding menu button on the panel to delete the calibration data of the selected channel.
3. Press **Clear all CALI data** corresponding menu button on the panel to delete all calibration data of the channels.

10 Remote Control

The SPD4000X supports communication with a computer via USB and LAN interfaces using a SCPI (Standard Commands for Programmable Instruments) compliant command set.

This chapter will introduce how to build a programming environment and explain the SCPI commands supported by the SPD4000X.

10.1 Way to Control

Using NI-VISA

Users can develop remote control programs for the instrument by using NI-VISA of NI (National Instrument Corporation). Regarding NI-VISA, there is a complete and real-time version (Run-Time Engine version). The complete version includes NI device drivers and a tool called NI MAX. NI MAX is a user interface used to control the device. The real-time version is much smaller than the full version, and it only includes NI device drivers.

After installing NI-VISA, use a USB cable to connect the SPD4000X (via the USB Device interface on the rear panel) to the computer, or use a network cable to connect the SPD4000X (via the LAN interface on the rear panel) to the local area network where the computer is located.

Based on NI-VISA, users can remotely control SPD4000X in two ways, one is through web service; the other is by developing custom programming combined with SCPI commands. For more information, please refer to the programming examples.

Using Sockets

Users can also use Sockets to communicate with SPD4000X based on the TCP/IP protocol through the network port. Socket communication is a basic communication technology of computer networks, which allows applications to communicate through network hardware and standard network protocol mechanisms built into the operating system. This method requires two-way communication between the instrument and the computer network through an IP address and a fixed port number.

The port of SPD4000X for Socket communication is 5025.

After connecting the SPD4000X (via the LAN interface on the rear panel) to the local area network where the computer is located with a network cable, the user can combine SCPI commands for custom programming to realize remote control of the SPD4000X. For more information, please refer to the programming examples.

10.2 Grammatical Conventions

SCPI commands are a tree-like hierarchical structure, including multiple subsystems. Each subsystem is composed of a root keyword and one or several hierarchical keywords. Command keywords are separated by colons ' : ', keywords are followed by optional parameter settings, commands and parameters are separated by ' spaces ', for multiple parameters, parameters are separated by commas ' , '. A question mark ' ? ' is added after the command line, which means to query this function.

Most SCPI commands are a mixture of upper and lower case letters. Capital letters indicate the abbreviations of commands, namely short commands. If you want better program readability, you can use long commands. E.g:

```
[:SOURce]:VOLTage[:SET]? CH1
```

Among them, the keyword VOLTage. You can enter VOLT or VOLTage, and combine upper and lower case letters at will. Therefore, VolTaGe, volt, and Volt are all acceptable. Other formats (such as VOL and VOLTAG) will produce errors.

- Braces ({ }) enclose the parameter selection. The braces are not sent with the command string.
- The vertical line (|) divides the parameter selection.
- Angle brackets (< >) indicate that a value must be assigned to the parameter inside the bracket. The angle brackets are not sent with the command string.
- Optional parameters are enclosed in square brackets ([]). If you do not specify a value for the optional parameter, the instrument will use the default value. For example, the [:SET] in the above command can be omitted (for example: 'VOLT? CH1'), and the command will operate on the current channel. The square brackets are not sent with the command string.

10.3 Command Summary

1. IEEE Common Command Subsystem
2. SOURCE Command Subsystem
3. WAVE Subsystem
4. SYSTEM Subsystem
5. STORAGE Subsystem
6. CALIBRATE Subsystem
7. MEASURE Subsystem

10.4 Command Description

10.4.1 IEEE Common Command Subsystem

1. *IDN?

Command format	*IDN?
Description	Query the manufacturer, device model, device serial port number, software version number
Example	*IDN?
Response	Siglent\ Technologies,SPD4306X,0123456789,4.1.2.4\n

2. *RST

Command format	*RST
Description	Restore the state of the device to the initial state
Example	*RST

3. *CLS

Command format	*CLS
Description	Clear the values of all event registers and clear the error list at the same time
Example	*CLS

4. *ESE

Command format	*ESE <number>
Description	Set the enable value of the standard event status register
Example	*ESE 16

5. *ESE?

Command format	*ESE?
Description	Query the enable value of the standard event status register
Example	*ESE?
Response	64

6. *ESR?

Command format	*ESR?
Description	Query and clear the event value of the standard event status register
Example	*ESR?
Response	0

7. *OPC

Command format	*OPC
Description	Operation complete
Example	*OPC

8. *OPC?

Command format	*OPC?
Description	Query whether the current operation is complete
Example	*OPC?
Response	1

9. *SRE

Command format	*SRE <number>
Description	Set the enable value of the status byte register
Example	*SRE 24

10. *SRE?

Command format	*SRE?
Description	Query the enable value of the status byte register
Example	*SRE?
Response	24

11. *STB?

Command format	*STB?
Description	Query the event value of the status byte register
Example	*STB?
Response	72

12. *TST?

Command format	*TST?
Description	Query the result of instrument self-test
Example	*TST?
Response	0

13. *WAI

Command format	*WAI
Description	Wait for all outstanding operations to complete before executing any other commands
Example	*WAI

10.4.2 SOURCE Command Subsystem

1. Set voltage value

Command format	[[:SOURce]:VOLTage[:SET] (CHn),{<value> MINimum MAXimum DEFault}
Description	Set the voltage value of the selected channel
Example	:SOURce:VOLTage:SET CH1,3
Description	Set the voltage value of CH1 to 3V

Command format	[[:SOURce]:VOLTage[:SET]? (CHn)
Description	Get the voltage value of the selected channel
Example	:SOURce:VOLTage:SET? CH1
Response	3.000000\n

2. Set OVP value

Command format	<code>[[:SOURce]:OVP (CHn),{<value> MINimum MAXimum DEFault}</code>
Description	Set the OVP value of the selected channel
Example	<code>:SOURce:OVP CH1,8</code>
Description	Set the OVP value of CH1 to 8V

Command format	<code>[[:SOURce]:OVP? (CHn)</code>
Description	Get the OVP value of the selected channel
Example	<code>:SOURce:OVP? CH1</code>
Response	<code>15.000000\n</code>

3. Get whether the channel triggers overvoltage protection

Command format	<code>[[:SOURce]:OVP:PROTECT:STATe? (CHn)</code>
Description	Get whether the channel triggers overvoltage protection
Example	<code>:SOURce:OVP:PROTECT:STATe? CH1</code>
Response	<code>0\n</code>

4. Set current value

Command format	<code>[[:SOURce]:CURRENT[:SET] (CHn),{<value> MINimum MAXimum DEFault}</code>
Description	Set the current value of the selected channel
Example	<code>:SOURce:CURRENT:SET CH1,2</code>
Description	Set the current value of CH1 to 2A

Command format	<code>[[:SOURce]:CURRENT[:SET]? (CHn)</code>
Description	Get the set current value of the selected channel
Example	<code>:SOURce:CURRENT:SET? CH1</code>
Response	<code>2.000000\n</code>

5. Set OCP value

Command format	[[:SOURce]:OCP (CHn),{<value> MINimum MAXimum DEFault}
Description	Set the OCP value of the selected channel
Example	:SOURce:OCP CH1,8
Description	Set the OCP value of CH1 to 8A

Command format	[[:SOURce]:OCP? (CHn)
Description	Get the OCP value of the selected channel
Example	:SOURce:OCP? CH1

6. Get whether the channel triggers overcurrent protection

Command format	[[:SOURce]:OCP:PROTECT:STATE? (CHn)
Description	Get whether the channel triggers overcurrent protection
Example	:SOURce:OCP:PROTECT:STATE? CH1
Response	0\n

7. Set OCP delay value

Command format	[[:SOURce]:OCP:DELAY (CHn),{<value> MINimum MAXimum DEFault}
Description	Set the delay value for OCP triggering of the selected channel
Example	OCP:DELAY CH1,1
Description	Set the delay value for OCP triggering of the CH1 to 1s

Command format	[[:SOURce]:OCP:DELAY? (CHn)
Description	Get the delay value for OCP triggering of the selected channel
Example	OCP:DELAY? CH1
Response	0.000000\n

8. Set OCP switch state

Command format	<code>[[:SOURce]:OCP:STATe (CHn),{ON OFF 0 1}</code>
Description	Set the OCP switch state of the selected channel
Example	<code>:SOURce:OCP:STATe CH1, 1</code>
Description	Set the OCP switch state of CH1 to ON

Command format	<code>[[:SOURce]:OCP:STATe? (CHn)</code>
Description	Get the OCP switch state of the selected channel
Example	<code>:SOURce:OCP:STATe? CH1</code>
Response	<code>1\n</code>

9. Set output state of the channel

Command format	<code>[[:SOURce]:OUTPut[:STATe] (CHn),{OFF ON 0 1}</code>
Description	Set output state of the selected channel (OFF ON 0 1)
Example	<code>OUTPut CH1,1</code>
Description	Turn on the output of CH 1

Command format	<code>[[:SOURce]:OUTPut[:STATe]? (CHn)</code>
Description	Get the output state of the selected channel
Example	<code>OUTPut? CH1</code>
Response	<code>0\n</code>

10. Set output state of all channels

Command format	<code>[[:SOURce]:OUTPut:ALL[:STATe] {OFF ON 0 1}</code>
Description	Set output state of all channels (OFF ON 0 1)
Example	<code>OUTPut:ALL 1</code>
Description	Turn on the output of all channels

Command format	<code>[[:SOURce]:OUTPut:ALL[:STATe]?</code>
Description	Get the output state of all channels
Example	<code>OUTPut:ALL?</code>
Response	<code>0\n</code>

11. Set output ON delay value of the channel

Command format	[:SOURce]: OUTPut:ON:DElay (CHn) ,{<value> MINimum MAXimum DEFault}
Description	Set output ON delay value of the selected channel
Example	OUTPut:ON:DElay CH1,3
Description	Set output ON delay value of CH 1 to 3s

Command format	[:SOURce]:OUTPut:ON:DElay? (CHn)
Description	Get output ON delay value of the selected channel
Example	OUTPut:ON:DElay? CH1
Response	0.000000\n

12. Set output OFF delay value of the channel

Command format	[:SOURce]:OUTPut:OFF:DElay (CHn),{<value> MINimum MAXimum DEFault}
Description	Set output OFF delay value of the selected channel
Example	OUTPut:OFF:DElay CH1,1
Description	Set output OFF delay value of CH 1 to 1s

Command format	[:SOURce]:OUTPut:OFF:DElay? (CHn)
Description	Get output OFF delay value of the selected channel
Example	OUTPut:OFF:DElay? CH1
Response	3.000000\n

13. Set series/parallel mode

Command format	[:SOURce]:OUTPut:TRACK <value> <value>: = {0 1 2 INDEPENDENT SERIES PARALLEL}
Description	Set the output mode of CH2/3
Example	OUTPut:TRACK 0
Description	Set the output mode of CH2/3 to independent mode

Command format	[:SOURce]:OUTPut:TRACK?
Description	Query the selected output mode of CH2/3
Example	OUTPut:TRACK?
Response	0\n

14. Set working mode

Command format	[:SOURce]:MODE {CH2 CH3},{0 1 2W 4W}
Description	Set the working mode of the selected channel
Example	MODE CH2,2W
Description	Set the working mode of the CH 2 to 2W

Command format	[:SOURce]:MODE? {CH2 CH3}
Description	Query the working mode of the selected channel
Example	MODE? CH2
Response	0\n

15. Set list voltage

Command format	[:SOURce]:LIST:VOLTage (CHn),<value1>,<value2>,...,<valuen>
Description	Set the voltage value of the first n steps of the selected channel
Example	LIST:VOLT CH1,1,2,3,4,5
Description	Set the voltage value for the first 5 steps of CH 1 to 1V, 2V, 3V, 4V, 5V

Command format	[:SOURce]:LIST:VOLTage? (CHn)
Description	Query the voltage value of effective steps
Example	LIST:VOLT? CH1
Response	LIST:VOLTs1.000,2.000,3.000,4.000,5.000\n

16. Set list current

Command format	[[:SOURce]:LIST:CURRent (CHn),<value1>,<value2>,...,<valuen>
Description	Set the current value of the first n steps of the selected channel
Example	LIST:CURR CH1,0.1,0.2,0.3,0.4,0.5
Description	Set the current value for the first 5 steps of CH 1 to 0.1A, 0.2A, 0.3A, 0.4A, 0.5A

Command format	[[:SOURce]:LIST:CURRent? (CHn)
Description	Query the current value of effective steps
Example	LIST:CURR? CH1
Response	LIST:CURR\s0.100,0.200,0.300,0.400,0.500\n

17. Set list running time

Command format	[[:SOURce]:LIST:TIME (CHn),<value1>,<value2>,...,<valuen>
Description	Set the running time of the first n steps of the selected channel
Example	LIST: TIME CH1,1,2,3,4,5
Description	Set the running time of the first 5 steps of the CH 1 to 1S, 2S, 3S, 4S, 5S

Command format	[[:SOURce]:LIST:TIME? (CHn)
Description	Query the running time of effective steps
Example	LIST:TIME? CH1
Response	LIST:TIME\s1.000,2.000,3.000,4.000,5.000\n

18. Clear all step data

Command format	[[:SOURce]:LIST:CLEAr (CHn)
Description	Clear all step data of the list for the channel
Example	LIST:CLEAr CH1
Description	Clear all step data of the CH 1

19. Set the number of cycles

Command format	[[:SOURce]:LIST:CYCLes [:COUNT] (CHn),{<value> MINimum MAXimum DEFault}
Description	Set the number of cycles
Example	LIST:CYCLes CH1,1
Description	Set the number of cycles of the list for CH 1 to 1

Command format	[[:SOURce]:LIST:CYCLes[:COUNT]? (CHn)
Description	Get the number of the list for the channel
Example	LIST:CYCLes? CH1
Response	1\n

20. Set the continuous state of list

Command format	[[:SOURce]:LIST:CONTInuous[:State] (CHn),{OFF ON 0 1}
Description	Set the continuous state of the list for the channel
Example	LIST:CONTInuous CH1,1
Description	Set the continuous state of the list for CH 1 to ON

Command format	[[:SOURce]:LIST:CONTInuous[:State]? (CHn)
Description	Get the continuous state of the list for the channel
Example	LIST:CONTInuous? CH1
Response	0\n

21. Set the running state of the list for a channel

Command format	[[:SOURce]:LIST:RUN[:State] (CHn),{OFF ON 0 1}
Description	Set the running state of the list for the channel
Example	LIST:RUN CH1,1
Description	Set the running state of the list for CH 1 to ON

Command format	[[:SOURce]:LIST:RUN[:State]? (CHn)
Description	Get the running state of the list for the channel
Example	LIST:RUN? CH1
Response	0\n

22. Set the running state of the list for all channels

Command format	[[:SOURce]:LIST:RUN:ALL[:State] {OFF ON 0 1}
Description	Set the running state of the list for all channels
Example	LIST:RUN:ALL 1
Description	Set the running state of the list for all channels to ON

23. Set the wait state of the list for a channel

Command format	[[:SOURce]:LIST:WAIT[:STATe] (CHn),{OFF ON 0 1}
Description	Set the wait state of the list for the channel
Example	:SOURce:LIST:WAIT:STATe CH1,1
Description	Set the wait state of the list for CH 1 to OFF

Command format	[[:SOURce]:LIST:WAIT[:STATe]? (CHn)
Description	Get the wait state of the list for the channel
Example	:SOURce:LIST:WAIT:STATe? CH1
Response	0\n

24. Set coupling state of the list for a channel

Command format	[[:SOURce]:LIST:COUP[:STATe] (CHn),{OFF ON 0 1}
Description	Set the coupling state of the list for the channel
Example	:SOURce:LIST:COUP:STATe CH1,1
Description	Set the coupling state of the list for CH 1 to ON

Command format	[[:SOURce]:LIST:COUP[:STATe]? (CHn)
Description	Get the coupling state of the list for the channel
Example	:SOURce:LIST:COUP:STATe? CH1
Response	0\n

25. Query the running state information of the list for a channel

Command format	<code>[:SOURce]:LIST:INFOrmation[:State]? (CHn)</code>
Description	Get the running state information of the list for a channel, include the number of steps currently running, the running state, the wait state, the time that the current step has run, the remaining time of the current step, the number of cycles completed, and whether all cycles have been completed
Example	<code>LIST:INFO? CH1</code>
Response	<code>step:1,run_state:0,wait_state:0,run_time:0.000,remain_time:0.000,completed_cycles:0,completed_state:0\n</code>

26. Set lock state of the device

Command format	<code>[:SOURce]:LOCK[:STATe] { OFF ON 0 1 }</code>
Description	Set the lock state of the device
Example	<code>:SOURce:LOCK:STATe ON</code>
Description	Set the lock state of the device to ON

Command format	<code>[:SOURce]:LOCK[:STATe]?</code>
Description	Get the lock state of the device
Example	<code>:SOURce:LOCK:STATe?</code>
Response	<code>0\n</code>

27. Clear the circuit protection status of the channel (overvoltage /overcurrent status)

Command format	<code>[:SOURce]:RESET:PROTeCt (CHn)</code>
Description	Clear the circuit protection status of the channel(overvoltage /overcurrent status)
Example	<code>:SOURce:RESET:PROTeCt CH1</code>
Description	Clear the circuit protection status of CH1(overvoltage /overcurrent status)

10.4.3 WAVE Subsystem

1. Set waveform drawing state for a channel

Command format	WAVE:DRAW[:STATe] (CHn),{VOLT CURR },{ OFF ON 0 1}
Description	Set the channel waveform drawing state
Example	WAVE:DRAW[:STATe] CH1,VOLT,1
Description	Set the CH 1 voltage waveform drawing state to ON

Command format	WAVE:DRAW[:STATe]? (CHn),{VOLT CURR }
Description	Get the channel waveform drawing state
Example	WAVE:DRAW? CH1,VOLT
Response	1\n

2. Set waveform drawing state for all channels

Command format	WAVE:DRAW:ALL[:STATe] {ON OFF 0 1}
Description	Set the waveform drawing state for all channels
Example	WAVE:DRAW:ALL[:STATe]
Description	Set the voltage waveform drawing state for all channels to ON

3. Set waveform saving time

Command format	WAVE:SAVE:TIME <value>,<value>,<value>
Description	Set waveform saving time
Example	WAVE:SAVE:TIME 1,30,30
Description	Set waveform saving time to 1 hour, 30 minutes and 30 seconds

Command format	WAVE:SAVE:TIME?
Description	Query waveform saving time
Example	WAVE:SAVE:TIME?
Response	0hours,0minutes,30seconds\n

4. Set waveform sampling period

Command format	WAVE:SAMPle[:PERIod] <value>
Description	Set waveform sampling period
Example	WAVE:SAMPle 200
Description	Set waveform sampling period to 200ms

Command format	WAVE:SAMPle[:PERIod]?
Description	Query waveform sampling period
Example	WAVE:SAMPle[:PERIod]?
Response	200\n

5. Set waveform saving switch state

Command format	WAVE:SAVE:STATe {OFF ON 0 1}
Description	Set the waveform saving switch state
Example	WAVE:SAVE:STATe 1
Description	Set to enable waveform saving

Command format	WAVE:SAVE:STATe?
Description	Get e waveform saving switch state
Example	WAVE:SAVE:STATe?
Response	1\n

10.4.4 SYSTEM Subsystem

1. Set key sound

Command format	[:SYStem]:SOUNd:KEY {OFF ON 0 1}
Description	Set the key sound switch state
Example	SOUNd:KEY 1
Description	Set the key sound switch state to ON

Command format	[:SYStem]:SOUNd:KEY?
Description	Get the key sound switch state
Example	SOUNd:KEY?
Response	1\n

2. Set alarm sound

Command format	[:SYStem]:SOUNd:ALARm {OFF ON 0 1}
Description	Set the alarm sound switch state
Example	SOUNd:ALARm 1
Description	Set the alarm sound switch state to ON

Command format	[:SYStem]:SOUNd:ALARm?
Description	Get the alarm sound switch state
Example	SOUNd:ALARm?
Response	1\n

3. Get link state of LAN

Command format	[:SYStem]:LAN:LINK?
Description	Get link state of LAN
Example	LAN:LINK?
Response	1\n

4. Set DHCP

Command format	[:SYStem]:DHCP {OFF ON 0 1}
Description	Set to obtain IP address dynamically or manually
Example	DHCP 1
Description	Set to obtain IP address dynamically

Command format	[:SYStem]:DHCP?
Description	Get the switch state of DHCP
Example	DHCP?
Response	1\n

5. Set IP address

Command format	[:SYStem]:LAN:IPADdress <value>
Description	Set IP address
Example	LAN:IPADdress 10.11.13.213

Command format	[:SYStem]:LAN:IPADdress?
Description	Get IP address
Example	LAN:IPADdress?

6. Set subnet mask

Command format	[:SYStem]:LAN:SMASk <value>
Description	Set subnet mask
Example	LAN:SMASk 255.255.255.0

Command format	[:SYStem]:LAN:SMASk?
Description	Get subnet mask
Example	LAN:SMASk?

7. Set gateway

Command format	[:SYStem]:LAN:GATeway <value>
Description	Set the gateway
Example	LAN:GATeway 10.11.13.1

Command format	[:SYStem]:LAN:GATeway?
Description	Get the gateway
Example	LAN:GATeway?

8. Get MAC address

Command format	[:SYStem]:LAN:MAC?
Description	Get MAC address
Example	LAN:MAC?

9. Set GPIB address

Command format	[:SYStem]:GPIB:ADDRess <value>
Description	Set GPIB address
Example	GPIB:ADDRess 3

Command format	[:SYStem]:GPIB:ADDRess?
Description	Get GPIB address
Example	GPIB:ADDRess?

10. Restore factory settings

Command format	[:SYStem]:FACTory:RESET
Description	Restore factory settings
Example	FACTory:RESET

11. Restore default data

Command format	[:SYStem]:DEFAult:RESET
Description	Restore default data (Excluding LAN and GPIB settings)
Example	DEFAult:RESET

10.4.5 STORAGE Subsystem

1. Get whether the specified universal data file is valid

Command format	[:STORage]:UNIVersal:FILE:STATe?
Description	Get whether the specified universal data file is valid
Example	:STORage:UNIVersal:FILE:STATe? 1
Response	Exist\n

2. Recall the specified universal data file

Command format	[:STORage]:UNIVersal:FILE:RECAll
Description	Recall the specified universal data file
Example	:STORage:UNIVersal:FILE:RECAll 1
Description	Recall the universal data file with serial number 1

3. Save the current universal data to the specified universal data file

Command format	[:STORage]:UNIVersal:FILE:SAVE
Description	Save the current universal data to the specified universal data file
Example	:STORage:UNIVersal:FILE:SAVE 1
Description	Save the current universal data to the specified universal data file with serial number 1

4. Delete the specified universal data file

Command format	[:STORage]:UNIVersal:FILE:DELEte
Description	Delete the specified universal data file
Example	:STORage:UNIVersal:FILE:DELEte 1
Description	Delete the specified universal data file with serial number 1

5. Get whether the specified list data file is valid

Command format	[:STORage]:LIST:FILE:STATe?
Description	Get whether the specified list data file is valid
Example	:STORage:LIST:FILE:STATe? 1
Response	Exist\n

6. Recall the specified list data file

Command format	[[:STORage]:LIST:FILE:RECAI]
Description	Recall the specified LIST data file
Example	:STORage:LIST:FILE:RECAI 1
Description	Recall the specified LIST data file with serial number 1

7. Save the current list data to the specified list data file

Command format	[[:STORage]:LIST:FILE:SAVE
Description	Save the current list data to the specified list data file
Example	:STORage:LIST:FILE:SAVE 1
Description	Save the current list data to the specified list data file with serial number 1

8. Delete the specified list data file

Command format	[[:STORage]:LIST:FILE:DELEte
Description	Delete the specified list data file
Example	:STORage:LIST:FILE:DELEte 1
Description	Delete the specified list data file with serial number 1

10.4.6 CALIBRATE Subsystem

1. Set calibration source

Command format	CALibrate:SOURce:SET {FACTORY USER 0 1}
Description	Set calibration source
Example	CALibrate:SOURce:SET FACTORY
Description	Set the calibration source to the factory calibration source

2. Get calibration source

Command format	CALibrate:SOURce:SET?
Description	Get calibration source
Example	:SOURce:VOLTage:SET? CH1
Response	0\n

10.4.7 MEASURE Subsystem

1. Get the measured voltage value

Command format	MEASure:VOLTage? (CHn)
Description	Get the voltage measurement value of the selected channel
Example	MEASure:VOLTage? CH1
Response	2.991442\n

2. Get the measured current value

Command format	MEASure:CURRent? (CHn)
Description	Get the current measurement value of the selected channel
Example	MEASure:CURRent? CH1
Response	1.999407\n

3. Get the measured power value

Command format	MEASure:POWER? (CHn)
Description	Get the measured power value of the selected channel
Example	MEASure:POWER? CH1
Response	19.959515\n

4. Get the running state of the channel

Command format	MEASure[:RUN]:MODE? (CHn)
Description	Get the running status of the selected channel
Example	MEASure:RUN:MODE? CH1
Response	CV\n

10.5 Web Service

10.5.1 Web Connection Method

The SPD4000X can be remotely controlled through its embedded web control interface.

The first connection method:

The computer is not connected to the network, and the SPD4000X and the PC computer are directly connected through a network cable (cross-over cable).

First, set up the computer. The following uses Windows 10 system as an example:

1. Select "Network and Internet" in Windows settings and click "Change adapter settings" in "Advanced network settings".

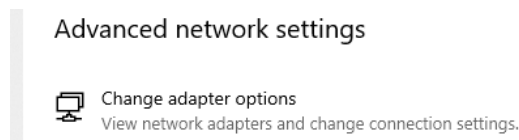

2. Right-click "Ethernet" and select "Properties", and double-click "Internet Protocol Version 4 (TCP/IPv4)" in the pop-up window.

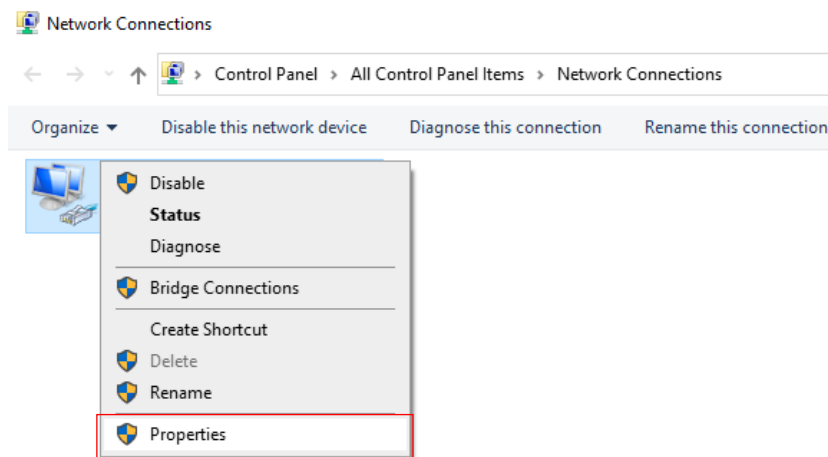

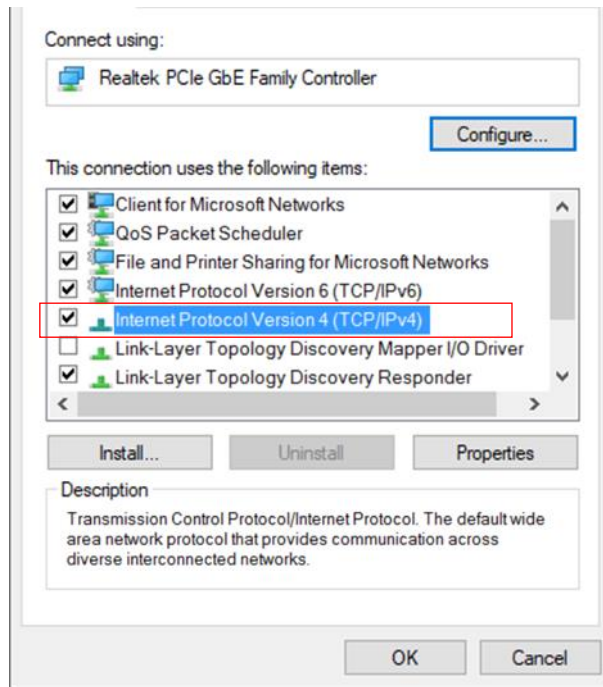

3. Select "Use the following IP address" to set the IP address, subnet mask and default gateway, and click "OK" after setting.

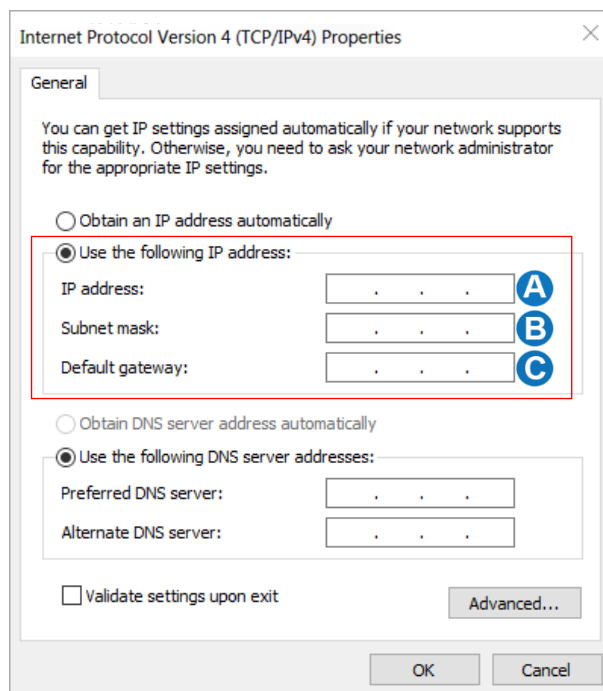

- A. Set an IP address different from SPD
- B. Set the same subnet mask as SPD
- C. Set the same gateway as SPD

4. The PC computer setting is completed.

Set the SPD3004X:

Refer to the previous chapter "9.2.2 LAN Setting", manually set SPD4000X to be the same as the PC computer subnet mask and default gateway, and set a different IP address. At this point, the PC and SPD4000X settings are completed, and the web page can be opened for remote control.

The second connection method:

SPD4000X and PC are connected to the same network. In the LAN setting interface, set DHCP to "ON", SPD4000X can automatically obtain IP or manually change the IP address to be connected.

10.5.2 Web Interface

After obtaining the IP address of the SPD4000X by any of the above methods, open the Google browser on the PC and directly enter the IP address in the input field to enter.

1. After configuring the voltage and current on the main interface, click the "Submit" to send the list data to the SPD4000X.

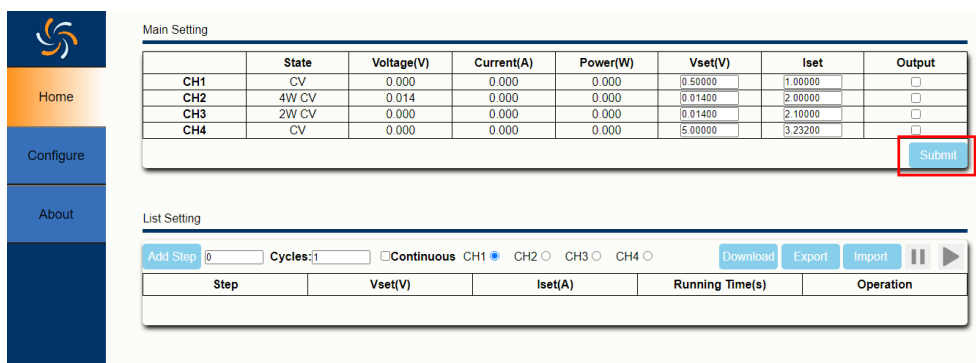

2. Click "Configure" in the left column to switch to the configuration interface. After performing function configuration on the configure interface, you need to click "Submit" at the arrow to send the data to the SPD4000X.

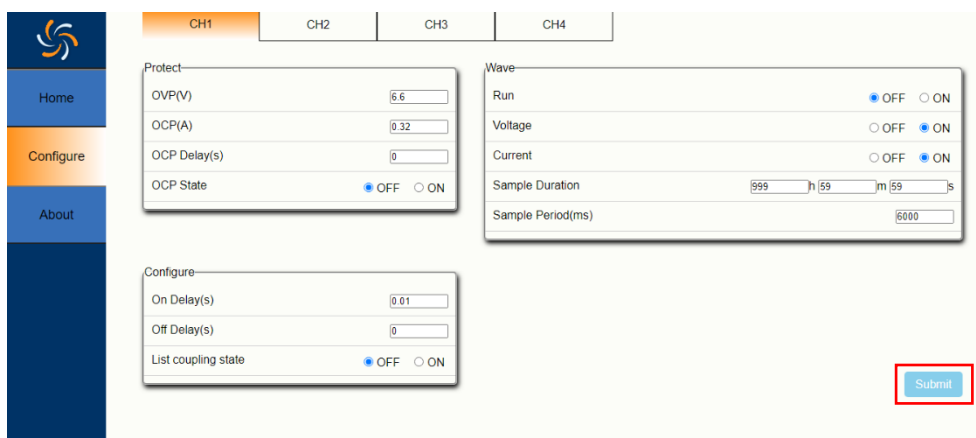

- Click "About" in the left column to view device information.

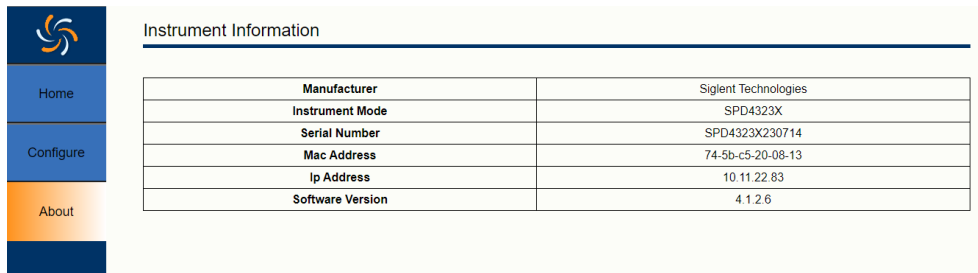

Instrument Information

Manufacturer	Siglent Technologies
Instrument Mode	SPD4323X
Serial Number	SPD4323X230714
Mac Address	74-5b-c5-20-08-13
Ip Address	10.11.22.83
Software Version	4.1.2.6

10.5.3 List Operation Method

- Select the channel for which you want to set the list.

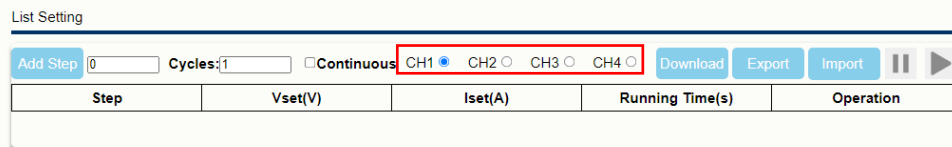

List Setting

Add Step: 0 Cycles: 1 Continuous CH1 CH2 CH3 CH4 Download Export Import || ▶

Step	Vset(V)	Iset(A)	Running Time(s)	Operation

- Add the number of list steps and set whether to loop the list. If the cyclic list is used, you need to set the number of cycles.

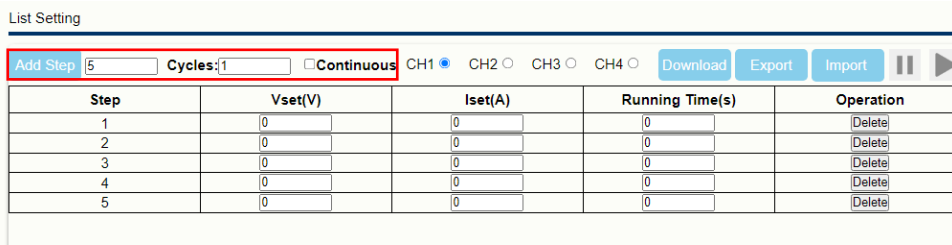

List Setting

Add Step: 5 Cycles: 1 Continuous CH1 CH2 CH3 CH4 Download Export Import || ▶

Step	Vset(V)	Iset(A)	Running Time(s)	Operation
1	0	0	0	Delete
2	0	0	0	Delete
3	0	0	0	Delete
4	0	0	0	Delete
5	0	0	0	Delete

- Set the voltage and current parameters of each step, and click "Download" to send the settings to the SPD4000X.

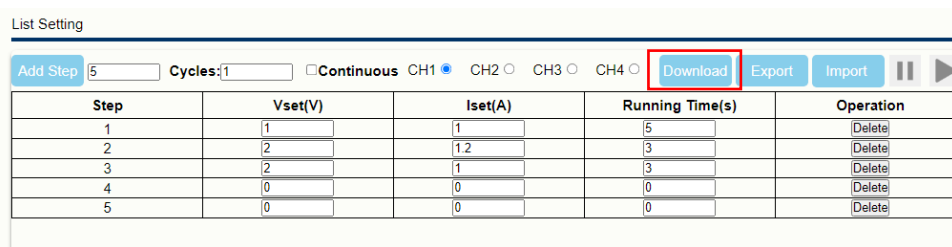

List Setting

Add Step: 5 Cycles: 1 Continuous CH1 CH2 CH3 CH4 Download Export Import || ▶

Step	Vset(V)	Iset(A)	Running Time(s)	Operation
1	1	1	5	Delete
2	2	1.2	3	Delete
3	2	1	3	Delete
4	0	0	0	Delete
5	0	0	0	Delete

- Turn on the "Output" switch of the channel and click "Submit". The SPD4000X will output according to the settings of the list steps.

Main Setting

	State	Voltage(V)	Current(A)	Power(W)	Vset(V)	Iset	Output
CH1	CV	0.000	0.000	0.000	0.50000	1.00000	<input checked="" type="checkbox"/>
CH2	4W CV	0.014	0.000	0.000	0.01400	2.00000	<input type="checkbox"/>
CH3	2W CV	0.000	0.000	0.000	0.01400	2.10000	<input type="checkbox"/>
CH4	CV	0.000	0.000	0.000	5.00000	3.23200	<input type="checkbox"/>

10.5.4 Import/Export List File

The SPD4000X supports exporting the settings of the voltage and current of the list steps to the outside storage in the form of .csv, and click "Export" to start the export operation.

List Setting

Add Step: Cycles: Continuous CH1 CH2 CH3 CH4

Step	Vset(V)	Iset(A)	Running Time(s)	Operation
1	1	1	5	Delete
2	2	1.2	3	Delete
3	2	1	3	Delete
4	0	0	0	Delete
5	0	0	0	Delete

The exported .csv file supports editing. After opening the .csv file, the user can customize the number of steps and other settings according to the format and then apply it to SPD4000X.

Click "Import" on the webpage and find the file path, then you can import the edited .csv file and apply it to SPD3004X.

List Setting

Add Step: Cycles: Continuous CH1 CH2 CH3 CH4

Step	Vset(V)	Iset(A)	Running Time(s)	Operation
1	1	1	5	Delete
2	2	1.2	3	Delete
3	2	1	3	Delete
4	0	0	0	Delete
5	0	0	0	Delete

In addition, the exported .CSV file can also be copied to a USB flash drive, and the application of List storage data can also be realized by inserting the USB flash drive into the power supply for external calling.

11 Troubleshooting

The following lists the power supply in the use of the process of possible failures and troubleshooting. When you encounter these faults, please follow the corresponding steps to deal with them. If you can't handle them, please contact **SIGLENT** in time.

1. If the power on key is pressed, the power supply is still black, and there is no display:
 - Check whether the power connector is connected properly.
 - After checking, please restart the power supply.
 - If the power supply can not be started normally, please contact **SIGLENT**.

2. No voltage output by output:
 - Check whether the voltage and current settings are correct
 - Use the default setting to reset the voltage and current output after restoring the factory settings.
 - If the power supply still cannot be used normally, please contact **SIGLENT**.

3. U disk cannot be recognized:
 - Check whether the U disk device can work normally.
 - Check whether the power USB HOST interface is working properly.
 - Make sure that the flash-type U disk is used, and that the power supply does not support hard disk-type U disk devices.
 - Re-plug the U disk, or restart the power and insert the U disk again.
 - If you still cannot use the U disk normally, please contact **SIGLENT**.

About SIGLENT

SIGLENT is an international high-tech company, concentrating on R&D, sales, production and services of electronic test & measurement instruments.

SIGLENT first began developing digital oscilloscopes independently in 2002. After more than a decade of continuous development, SIGLENT has extended its product line to include digital oscilloscopes, isolated handheld oscilloscopes, function/arbitrary waveform generators, RF/MW signal generators, spectrum analyzers, vector network analyzers, digital multimeters, DC power supplies, electronic loads and other general purpose test instrumentation. Since its first oscilloscope was launched in 2005, SIGLENT has become the fastest growing manufacturer of digital oscilloscopes. We firmly believe that today SIGLENT is the best value in electronic test & measurement.

Headquarters:

SIGLENT Technologies Co., Ltd
Add: Bldg No.4 & No.5, Antongda Industrial
Zone, 3rd Liuxian Road, Bao'an District,
Shenzhen, 518101, China
Tel: + 86 755 3688 7876
Fax: + 86 755 3359 1582
Email: sales@siglent.com
Website: int.siglent.com

North America:

SIGLENT Technologies America, Inc
6557 Cochran Rd Solon, Ohio 44139
Tel: 440-398-5800
Toll Free: 877-515-5551
Fax: 440-399-1211
Email: info@siglentna.com
Website: www.siglentna.com

Europe:

SIGLENT Technologies Germany GmbH
Add: Staetzlinger Str. 70
86165 Augsburg, Germany
Tel: +49(0)-821-666 0 111 0
Fax: +49(0)-821-666 0 111 22
Email: info-eu@siglent.com
Website: www.siglenteu.com

Follow us on
Facebook: SiglentTech

